

GMRS® Distal Femoral Surgical Protocol

Global Modular Replacement System



Acknowledgements

Stryker would like to thank the following surgeons for their contributions in developing the Global Modular Replacement System (GMRS).

Jeffery Eckardt, M.D.

Rainer Kotz, M.D.

Martin Malawer, M.D.

Mario Mercuri, M.D.

Stryker would also like to thank the following surgeons for their input in reviewing this surgical technique.

Francis Hornicek, M.D.

Lawrence Menendez, M.D.

Richard Lackman, M.D.

Franklin Sim, M.D.

H. Thomas Temple, M.D.

GMRS Distal Femoral components are marketed in the United States for use with bone cement.

GMRS® Distal Femoral

Surgical Protocol

Table of Contents

Introduction	2
Description of the Distal Femoral Global Modular Replacement System	4
Indications/Contraindications	6
Surgical Protocol	7
Measuring Resection Length	8
Rotational Alignment	9
Femoral Osteotomy	10
Preparation of the Femur	11
Proximal Tibial Resection	12
Tibial Preparation for the Modular Rotating Hinge (MRH) Tibial Baseplate	13
Establishing the depth of the tibial cut	14
Proximal Tibial Resection	15
Femoral and Tibial Trial Assembly	17
Trial Reduction	18
Assembly of the Tibial Stem Implant	20
Titanium Tri-Fluted Stem Option	20
Assembly of the Femoral Prosthesis	21
Implantation and Orientation of the Tibial and Femoral Prosthesis	23
Final Implant Assembly	24
Appendices	
Appendix I – Establishing the Depth of the Tibial Cut	
Option A: Femoral Referencing Method	28
Option B: Extra-Medullary Referencing	30
Option C: Intra-Medullary Referencing	34
Appendix II – Tibial Preparation for the All-Poly Tibial Component	40
Appendix III – Taper Disassembly	46
Implant Listing and Resection Length Overview Chart	48, 49



Introduction

The GMRS Distal Femoral Components are based on over a quarter of a century of clinical history. Patella kinematics have been enhanced by incorporating a deepened patellar track to articulate with the Duracon patellae. The GMRS standard Distal Femur accepts the Modular Rotating Hinge (MRH) Tibial Bearing Component, Bushings, Axle and Bumper for seamless integration with the MRH resurfacing Tibial Baseplate.





The Stem options for the GMRS Distal Femoral Replacement are unrivaled and now offer six cemented stem options: straight, curved and long curved; each type with or without extra-cortical porous-coated body sections.



Description of the Distal Femoral Modular Replacement System

The GMRS System was developed to meet the unique needs of patients who require reconstruction of large segmental defects for tumors, failed previous arthroplasty, or trauma. This system is designed to:

- Reconstruct large segmental defects of the knee
- Reconstruct osteoarticular defects of varying sizes
- Allow for variation and intra-operative changes of the surgical plan.

The system consists of distal femoral components, extension pieces and stems. It also includes a complete set of trial components and instrumentation.

The modular implants are assembled by impacting a male/female taper design, securely locking them together.

Distal Femoral Components



Stem Components



Distal Femoral Components

The distal femoral components are available in two sizes, small and standard, and both are available in left and right configurations. The standard size distal femoral component measures 60mm in the M/L and 54mm in the A/P. The small size distal femoral component measures 52mm in the M/L and 45mm in the A/P. Both sizes have a 65mm replacement length. All distal femoral components have a built-in 6° Valgus offset and utilize the Modular Rotating Hinge (MRH) Knee components.

NOTE: The small distal femoral component uses dedicated small bushings and a small axle.

Stem Components Cemented Stems

The GMRS cemented stems are available in six styles: straight, curved and long curved; each style with or without extra-cortical porous-coated body sections. The extra-cortical porous-coated body section has a 40mm replacement length. The stems are also available without the extra-cortical porous-coated body section, with an 11mm replacement length.

All stems are available in 8mm, 9mm, 10mm, 11mm, 13mm, 15mm and 17mm diameters. Their respective seat diameters at the resection level are as follows:

Stem Diameter	Seat Diameter
Ø 8, 9mm	Ø 22mm
Ø 10, 11mm	Ø 24mm
Ø 13mm	Ø 28mm
Ø 15mm	Ø 32mm
Ø 17mm	Ø 36mm

The stems are designed to be cemented into the medullary canal. Optional stem centralizers are available for the 10-17mm diameter (for the straight and short-curved stems only).

NOTE: The small cemented stems (8mm, 9mm and 10mm diameters) are intended to be used with the small distal femoral component.

Extension Pieces

The extension pieces are used to customize the replacement length and are available in 30mm, 40mm, 50mm, 60mm, 70mm, 80mm, 100mm, 120mm, 140mm, 160mm, 180mm, 200mm and 220mm lengths. This component features a male and female taper, which attaches a stem to a distal femoral component.

Extension Piece



All Poly Tibial Component



MRH Tibial Baseplate



Tibial Components

All-Polyethylene Tibial Component

The All-Poly Tibial Component is available in five sizes (XS,S,M,L,XL), each in 4 thicknesses (8mm, 11mm, 16mm and 21mm). The component is designed to accept the long All-Poly Tibial Bearing Component only (6481-2-103).

NOTE: The All-Poly Tibial Component is intended for use when it can be adequately supported by cortical bone around its periphery.

Modular Rotating Hinge Tibial Baseplate

If the bone quality is suspect or the component cannot be properly supported, the Modular Rotating Hinge (MRH) tibial baseplate is recommended.

The MRH Tibial Baseplate is available in four sizes (Small 1, Small 2, Medium 2 and Large 2), with modular stem options (80mm and 155mm lengths, 10-23mm diameter). The tibial inserts are available in two sizes (Small 1 / Small 2 and Medium 2 / Large 2), each in 5 thicknesses (10mm, 13mm, 16mm, 20mm and 24mm). The MRH Tibial Baseplate is designed to accept the MRH Tibial Bearing Component only (6481-2-100). A comprehensive range of modular stems are available to be assembled with these Tibial Baseplates.

Trial Components

The implant system is complemented with a complete set of trial components. The trial components are replicas of their corresponding implants; however, they have non-locking trunnions. The trials are satin-finished and have no coatings, so that they can easily be distinguished from the implants. A 30mm Trial Extension Piece also functions as the Trial Extra-Cortical Body. Together with the Trial Cemented Stem, it forms the Trial Stem with extra-cortical porous-coated body.

Indications

The Modular Replacement Systems are intended for use in patients requiring extensive reconstruction of the hip joint and/or knee joint, including knee fusions, necessitated by extensive bone loss due to trauma, failed previous prosthesis and/or tumor resection.

Contraindications

A. As related to Bone Tumors:

Not all bone tumors may be treated successfully by segmental resection. Any condition that may have already resulted in either local or distant spread of the tumor may be a contraindication. Examples of such conditions include:

- Pathological fracture;
- Overt infection;
- Inopportune placement of biopsy incision; and,
- Rapid disease progression beyond a respectable margin.

Each patient must therefore be individualized and carefully evaluated by appropriate staging techniques prior to consideration of segmental replacement.

B. As related to Failed Previous Prosthesis and Trauma:

- Any active or suspected latent infection in or about the operative joint.

- Any mental or neuromuscular disorder which would create an unacceptable risk of prosthesis instability, prosthesis fixation failure, or complication in postoperative care.
- Bone stock compromised by disease, infection, or prior implantation, which cannot provide adequate support and fixation of the prosthesis.
- HA coated stems are contraindicated in situations where bone stock is inadequate to support press fit application.

See package insert for warnings, precautions, adverse effects, information for patients and other essential product information.

Before using GMRS instrumentation, verify:

- Instruments have been properly disassembled prior to cleaning and sterilization;
- Instruments have been properly assembled post-sterilization;
- Instruments have maintained design integrity; and,
- Proper size configurations are available.

For Instructions for Cleaning, Sterilization, Inspection and Maintenance of Orthopaedic Medical Devices, refer to LSTPI-B.

GMRS® Distal Femoral Surgical Protocol

**Global Modular Replacement System
Distal Femoral Resection for
Large Segmental Replacements
Surgical Protocol**

This publication sets forth detailed recommended procedures for using Stryker Orthopaedics devices and instruments. It offers guidance that you should heed, but, as with any such technical guide, each surgeon must consider the particular needs of each patient and make appropriate adjustments when and as required.

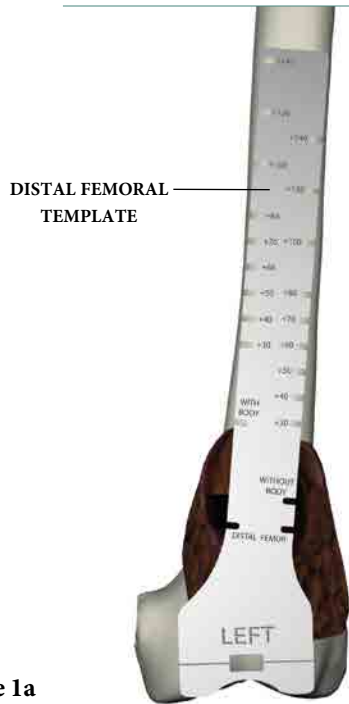

Figure 1a

Measuring Resection Length

The Distal Femoral Template can be used to guide the resection to a level that can be reproduced by the available implants. The Distal Femoral Template is placed on the bone so that the silhouette of the template coincides with the distal condyles of the femur (Figure 1a).

The Distal Femoral Template is read at the appropriate marking depending on whether the stem being used is with or without extra-cortical porous-coated body section. The anterior cortex of the femur is marked with a Bovie or similar device to indicate the resection level.

It is important to note that if the condyles of the prosthesis are placed at the level of the pre-operative condyles (i.e. the femoral prosthesis is the exact length of the resected distal femur), an 18mm tibial resection is required for an MRH baseplate. Typically, 10-12mm are removed from the proximal tibia. The femoral resection is therefore usually about 6-8mm longer than the prosthesis.

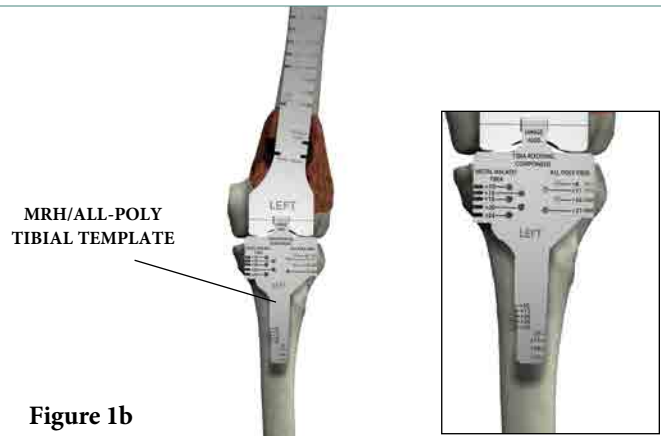

Figure 1b

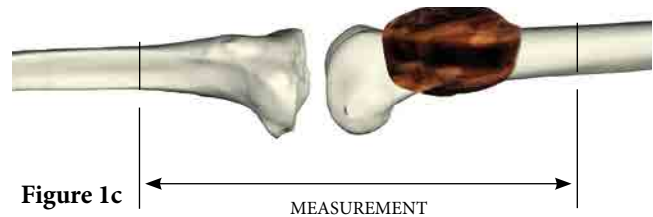



Figure 1c

Alternatively, the **MRH/All-Poly Tibial Template** can be attached to the Distal Femoral Template. The slots in the Tibial Template coincide with the level of the proximal tibial resection for the different All-Poly Tibial components or the MRH Tibial Inserts (Figure 1b). This is a provisional marking only; no bone is cut at this stage.

NOTE: It is important to ensure proper patellar tracking. The length of the femoral resection and prosthetic replacement must be considered with the tibial resection to recreate leg length and establish proper patellar tracking. Patellar tracking, tibial cut, and leg length must be taken into consideration when making the femoral resection.

SURGICAL TIP: As an aid to restoring leg length, a reference measurement can be established across the joint. With a Bovie or similar device, a mark is made on the femur, proximal to the femoral resection, along with a mark on the tibia, distal to the tibial resection. The distance between these marks can be measured before the resection is made, and checked again, with the trials or implants in place, after the resection is made (Figure 1c).

6496-9-069
Distal Femoral Template
GMRS Tray No: 1A



6496-9-071
MRH/All-Poly Tibial Template
GMRS Tray No: 1A



Note: Frame color around each instrument indicates the corresponding GMRS instrument tray color.
Instruments without a colored frame are instruments from the MRH or the Duracon TS Instrument Trays.

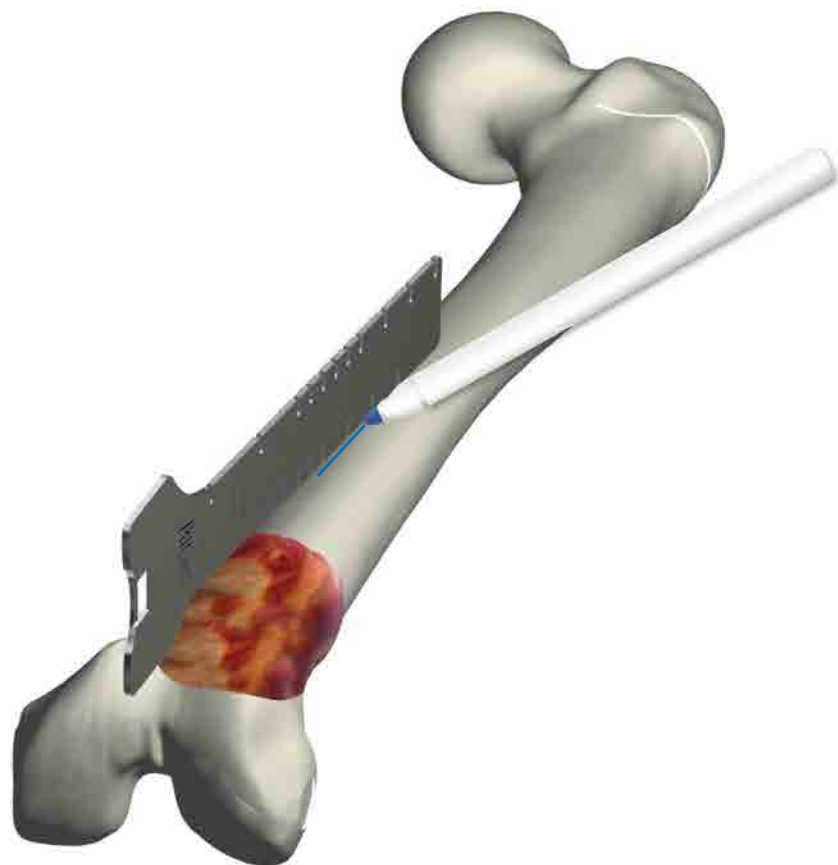

Figure 2

Rotational Alignment

Using a straight edge (e.g. the Distal Femoral Template), the anterior cortex of the distal femur is marked above the resection level in line with the trochlear groove of the distal femur (**Figure 2**).

The line should be directly anterior to the linea aspera. This reference mark will be used later to aid in rotational orientation of the prosthetic components. Rotational alignment can also be determined or verified during trial evaluation.

The Stem Implants and Trials are marked in line with the trochlear groove of the Distal Femoral Component.

As a guide to rotational orientation, the alignment marking on the implant stem can be oriented to the mark made on the anterior cortex above the resection level.

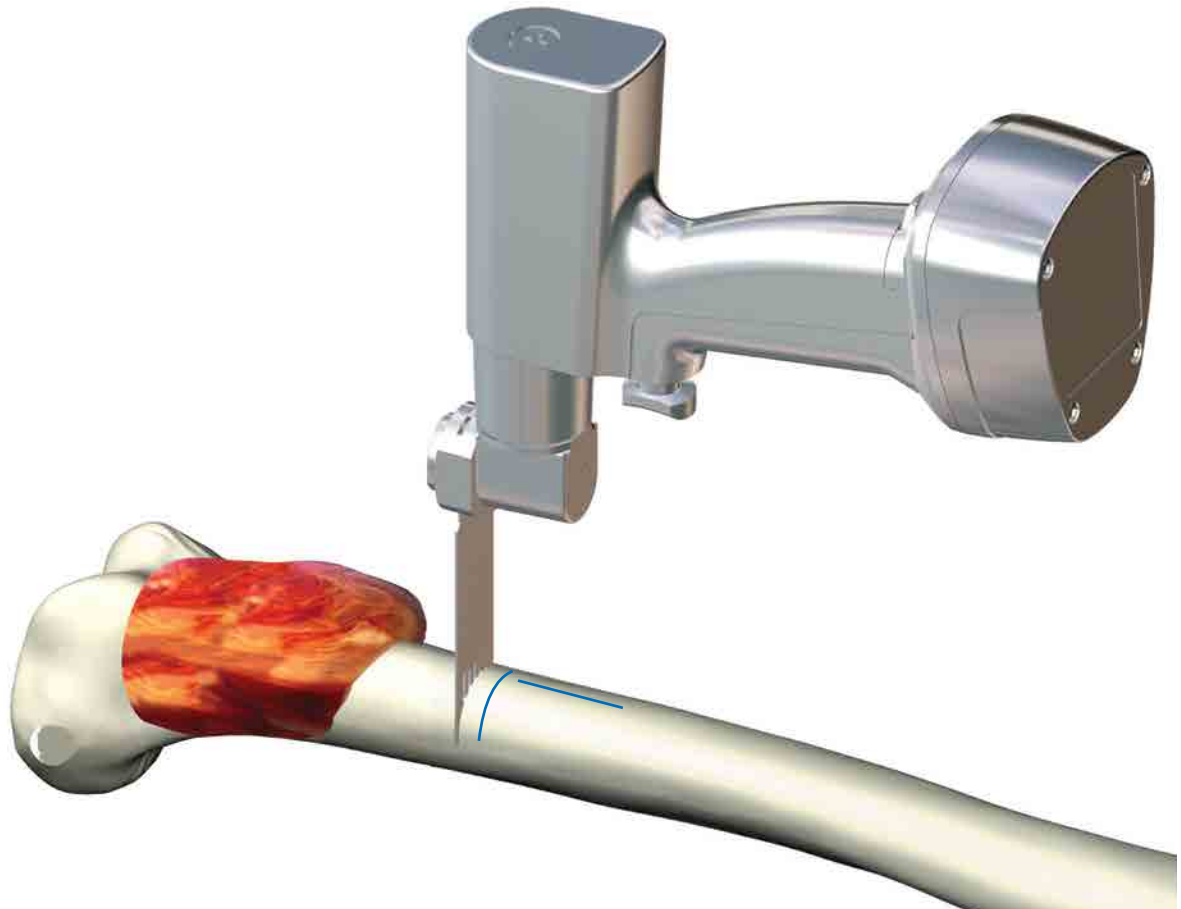

Figure 3

Femoral Osteotomy

All remaining soft tissue at the level of transection is cleared. The osteotomy, perpendicular to the femoral shaft, is performed after the posterior and medial structures have been protected and retracted (**Figure 3**); special care is taken to protect the Femoral Artery.

SURGICAL TIP: It is preferable to resect the femur a millimeter or two distal to the marked resection level. This will allow the face reamer (see **Figure 4** on *page 11*) to plane accurately up to the mark at a 90° angle.

NOTE: It is extremely important not to distract the extremity following the resection. The end of the femoral osteotomy should be kept well padded to avoid injuring the femoral vessels. The length of the resected specimen should be checked and measured again following resection.



Figure 4

Preparation of the Femur

A Flexible Guide Wire is inserted into the femoral canal. Flexible Reamers are utilized to progressively ream the canal to the appropriate diameter.

To permit an adequate cement mantle, the canal should be reamed to 2mm larger than the selected stem of the prosthesis. (Note: The seven stem diameters are 8mm, 9mm, 10mm, 11mm, 13mm, 15mm and 17mm).

The appropriate **Facing Reamer (Figure 4)** is used to plane the osteotomy site so as to ensure direct contact and accurate seating of the prosthesis upon the cortices.

6496-9-2XX

Facing Reamer



GMRS Tray No: 4A

Stem Diameter	Suggested Flexible Reamer Diameter	Seat Diameter
Ø 8mm	Ø 10mm	Ø 22mm
Ø 9mm	Ø 11mm	Ø 22mm
Ø 10mm	Ø 12mm	Ø 24mm
Ø 11mm	Ø 13mm	Ø 24mm
Ø 13mm	Ø 15mm	Ø 28mm
Ø 15mm	Ø 17mm	Ø 32mm
Ø 17mm	Ø 19mm	Ø 36mm

The chosen Trial Stem is inserted to evaluate ease of insertion and an appropriate cement mantle. The trial cemented stems are exactly size for size as compared to the implant and do not include the cement mantle.

If there is any difficulty inserting the trial stem, continue reaming until the Trial Stem fits freely into the canal, or re-assess the Trial Stem size. It is extremely important to verify the close apposition of the seat of the Trial Stem to the cortex.

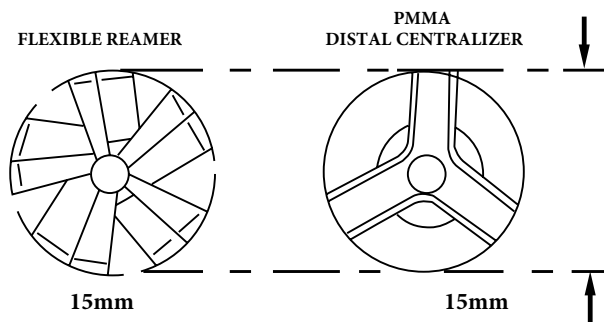

Figure 5

Optional stem centralizers are available for the 10-17mm diameter stems (for the 102mm and 127mm length stems only). The last size Flexible Reamer used corresponds to the diameter of the distal centralizer necessary for correct positioning of the stem tip (Figure 5).

Proximal Tibial Resection

This technique illustrates the preparation for the Modular Rotating Hinge Tibial Baseplate which articulates with the GMRS Distal Femur. The technique for the Kinematic Rotating Hinge All-Poly Tibial Component which also articulates with the GMRS Distal Femur, is illustrated in Appendix II. The required proximal tibial cut is neutral to the tibial axis in all planes, i.e. cut in classic alignment with no posterior slope. The amount of bone to be removed, when taken into consideration with the femoral resection, will reconstruct the pre-operative joint line and leg length.

The instrumentation provides four options for determining the resection level of the proximal tibia. The first option illustrates the method for establishing the depth of the tibial cut referenced from intra-medullary trial stems. The other three options can be reviewed in *Appendix I*.

Tibial Preparation for the Modular Rotating Hinge (MRH) Tibial Baseplate

The proximal tibial cut for the Modular Rotating Hinge baseplate is a neutral cut, i.e. classical alignment with no posterior slope.

The MRH Tibial Baseplate comes in four sizes (S1, S2, M2, L2) with multiple stem options. Each size of Tibial Baseplate has insert thicknesses of 10mm, 13mm, 16mm, 20mm and 24mm. The 4mm thickness of the baseplate is included in the insert thickness for the total thickness.

To properly re-establish the jointline, the articulating surface of the tibial insert should be at the correct level to ensure proper patellar position. Establishing the depth and performing the actual resection of the tibia for the Modular Rotating Hinge (MRH) Knee is as follows:

Select the appropriate Tibial Template by referencing the size determined during pre-operative planning. The correct size is the one that best covers the surface of the tibia without overhanging the medial tibial plateau. The Templates are used for selecting the size of the Tibial Component and as a guide to locating the center of the cavity to be prepared for the stem. The center of the hole in the template can be marked with a sharp awl to facilitate canal preparation.

NOTE: All MRH related Instruments and Trial Components are located in the MRH Instrumentation Kit

Using the 3/8" IM Drill an entry hole is prepared in the location determined by the pre-operative x-rays, or just anterior to the ACL insertion (**Figure 6a**).

The proximal tibial canal is prepared manually with a **T-Handle** attached to a fluted IM Reamer to accept the appropriate stem of the baseplate. The Reamer has cutting teeth that cut when the Reamer turns in a clockwise direction while being advanced. If the reaming becomes difficult, the Reamer should be removed, and its teeth should be cleared.

Fluted IM Reamers, available in diameters 8-23mm, are sequentially advanced into the medullary canal until the tip of the **Tibial Reamer Depth Gauge** reaches the level of the most prominent bony aspect of the proximal tibia (**Figure 6b**).

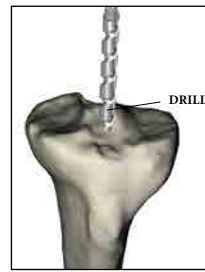

Figure 6a

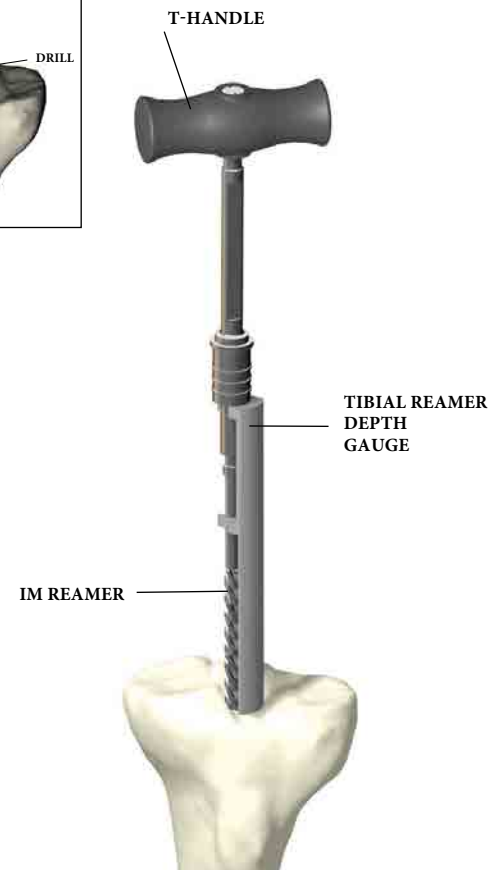

Figure 6b

NOTE: Reamer Depth Gauges for tibial preparation are available in two lengths: 80mm and 155mm refer to the depth required to properly seat the implant with the respective 80mm and 155mm length Stem.

6838-7-673

3/8" IM Drill



IM Reamer Tray R2

6266-5-410

T-Handle



IM Reamer Tray R2

6633-9-4XX

IM Reamer



IM Reamer Tray R2

6481-1-05X

MRH Depth Gauge



IM Reamer Tray R2

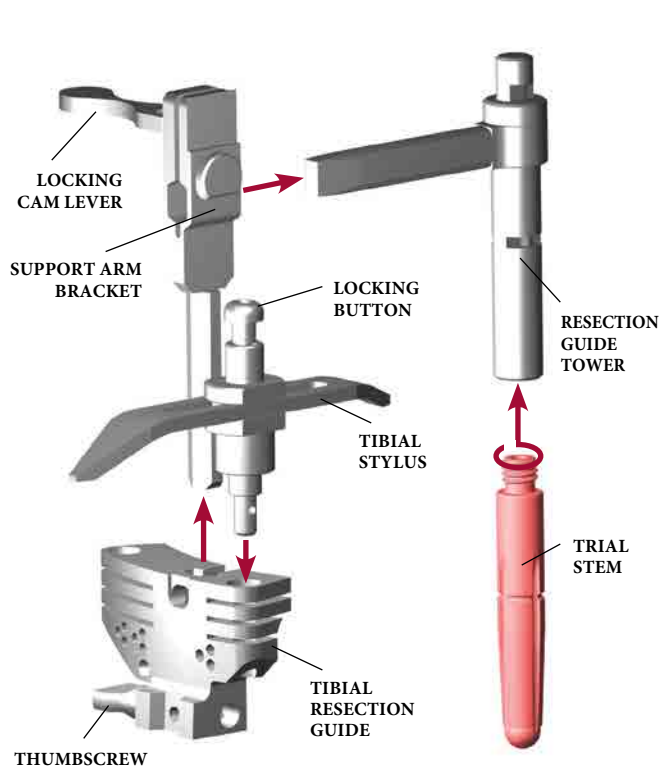

Figure 7a

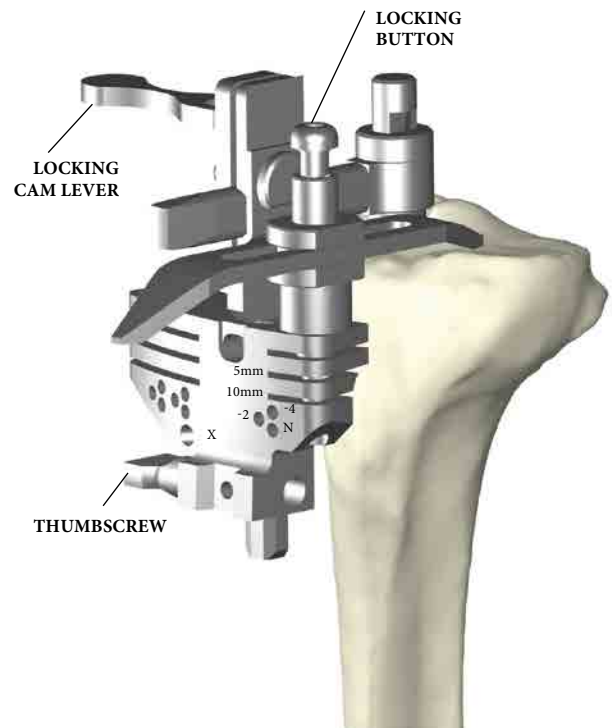

Figure 7b

Establishing the depth of the tibial cut

Based on the last size reamer used, the appropriate diameter and length **Trial Stem** is assembled to the **Resection Guide Tower**. Assemble the **Tibial Stylus** to the appropriate, left or right, **Tibial Resection Guide** by depressing the locking button on top of the Tibial Stylus, inserting the stylus into either the medial or lateral hole on the top of the Tibial Resection Guide and releasing the button to lock the stylus into place. Insert the **Support Arm Bracket** through the Tibial Resection Guide and tighten the thumbscrew to lock in place. The Tibial Resection Guide Assembly is then inserted onto the Resection Guide Tower Assembly (**Figure 7a**).

This instrument assembly is inserted into the tibial canal until the stylus references the desired point on the tibial plateau (**Figure 7b**). The locking cam lever on the Support Arm Bracket can be loosened to slide the Tibial Resection Guide against the tibia and then re-lock in place.

NOTE: The Tibial Stylus can be used to determine a 12mm or an 18mm resection level. If the distal most aspect of the femoral prosthesis is placed at the same location of the original anatomy, an 18mm resection is required (8mm for the Tibial Bearing Component + 10mm for the thinnest insert with the MRH Baseplate). Typically, 10-12mm is removed from the proximal tibia. Therefore, the femoral resection is usually about 6mm longer than the prosthesis.

6778-6-XXX

Trial Stem



Trial Stem Tray R6

6633-9-428

Resection Guide Tower



Extension Gap Prep. Tray R3

6496-9-068

Tibial Stylus



Trial Stem OR Tray 8A

6496-9-051/052

Tibial Resection Guide



Trial Stem Tray R6 OR Tray 8A

8200-0034

Support Arm Bracket



Trial Stem Tray R6

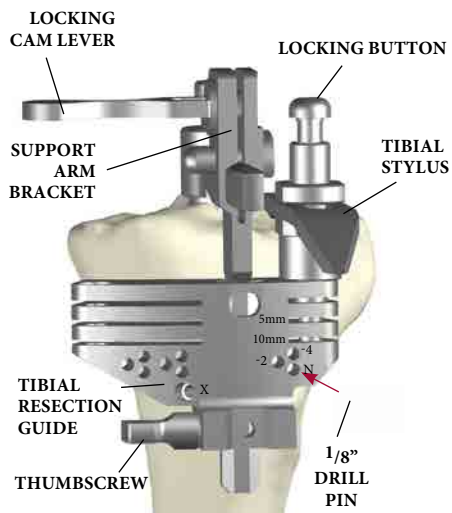

Figure 7c



Figure 7d

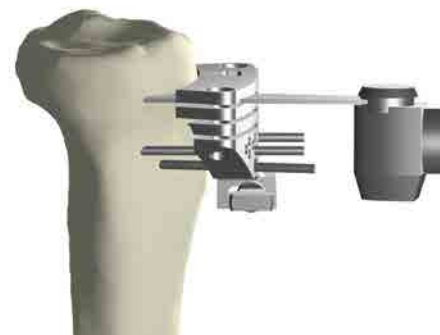

Figure 7e

Proximal Tibial Resection

Once the resection level is established, secure the Tibial Resection Guide to the anterior tibia using the 1/8" drill pins, drilling through the "N" holes (Figure 7c).

Once pinned to the tibia, loosen the thumbscrew of the Tibial Resection Guide and remove the Resection Guide Tower assembly and Tibial Stylus, leaving the Tibial Resection Guide pinned in place. Pinning through the "X" Pin Hole will further secure the Tibial Resection Guide to the tibia (Figure 7d).

Resect the tibial plateau through the most proximal slot in the Tibial Resection Guide. Use of a .050" (1.27mm) sawblade is recommended for an accurate resection (Figure 7e).

Additional bone may be resected by repositioning the Tibial Resection Guide over the pins in the -2 or -4 holes to resect an additional 2mm or 4mm of bone, respectively (see Figure 7d).

NOTE: If the "X" pin hole is used, this pin must be removed prior to repositioning the Tibial Resection Guide.

The Tibial Resection Guide is removed by first removing the "X" pin, then sliding the Tibial Resection Guide off over the two 1/8" drill pins and then removing the pins with the Pin Puller.

NOTE: The 5mm and 10mm slots in the tibial resection guide can be used in revision or trauma cases where bone loss or fracture respectively, necessitates the use of half or full tibial augments.

5800-4-125

1/8" Drill Pin



Extension Gap
Prep Tray R3

6633-7-605

Pin Puller



Extension Gap
Prep Tray R3

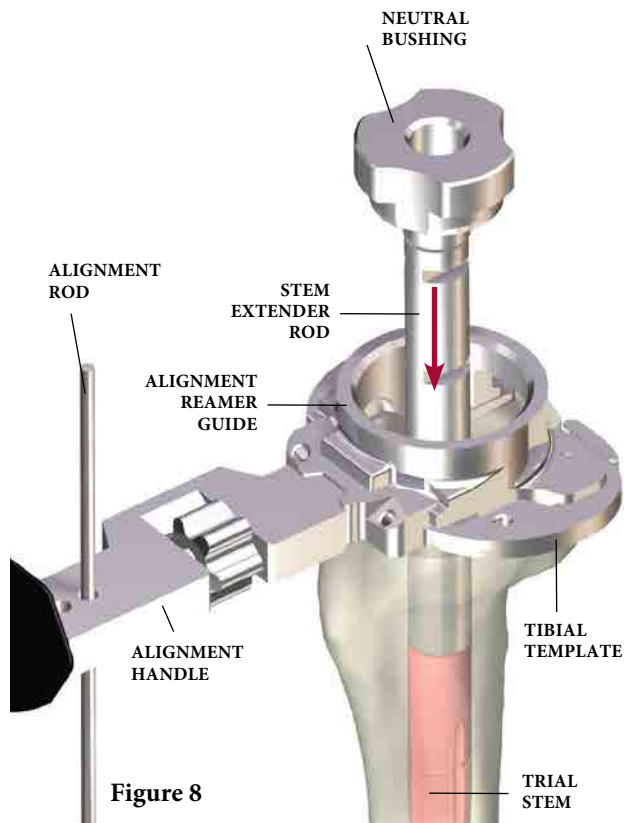



Figure 8

Use the **Stem Extender Rod**, attached to a **Trial Stem**, through the **Alignment Reamer Guide** and **Neutral Bushing** to center the **Tibial Template** with the Stem construct in the canal (**Figure 8**).

With the knee in full flexion, and the **Alignment Handle** attached to the Template, an **Alignment Rod** is placed through the “NT” hole position of the Handle to verify alignment.

The tibial tubercle will normally be positioned just lateral to the pin which should be centered distally over the center of the ankle.

6633-9-426
Stem Extender Rod
Tibial Preparation Tray R8



6778-6-XXX
Trial Stem
Trial Stem Tray R6



6633-9-861
Alignment Reamer Guide
MRH Instrument Tray H1



6633-9-910
Neutral Bushing
Tibial Preparation Tray R8



6633-9-8XX
Tibial Template
Tibial Preparation Tray R8



6633-7-250
Alignment Handle
Extension Gap Preparation Tray R3



6838-7-2X0
Alignment Rod Extension Gap Preparation Tray R3



6633-9-900
Stem Boss Reamer Bushing
MRH Instrument Tray H1



6481-8-520
Tibial Stem Boss Reamer
MRH Instrument Tray H1





Figure 9

When alignment is correct, the Template is secured with Headed Nails or pins through holes located anteriorly and posteriorly on the template.

Ream the Stem Boss using the **Stem Boss Reamer Bushing** and **Tibial Stem Boss Reamer** to the “Boss” depth marking (**Figure 9**).

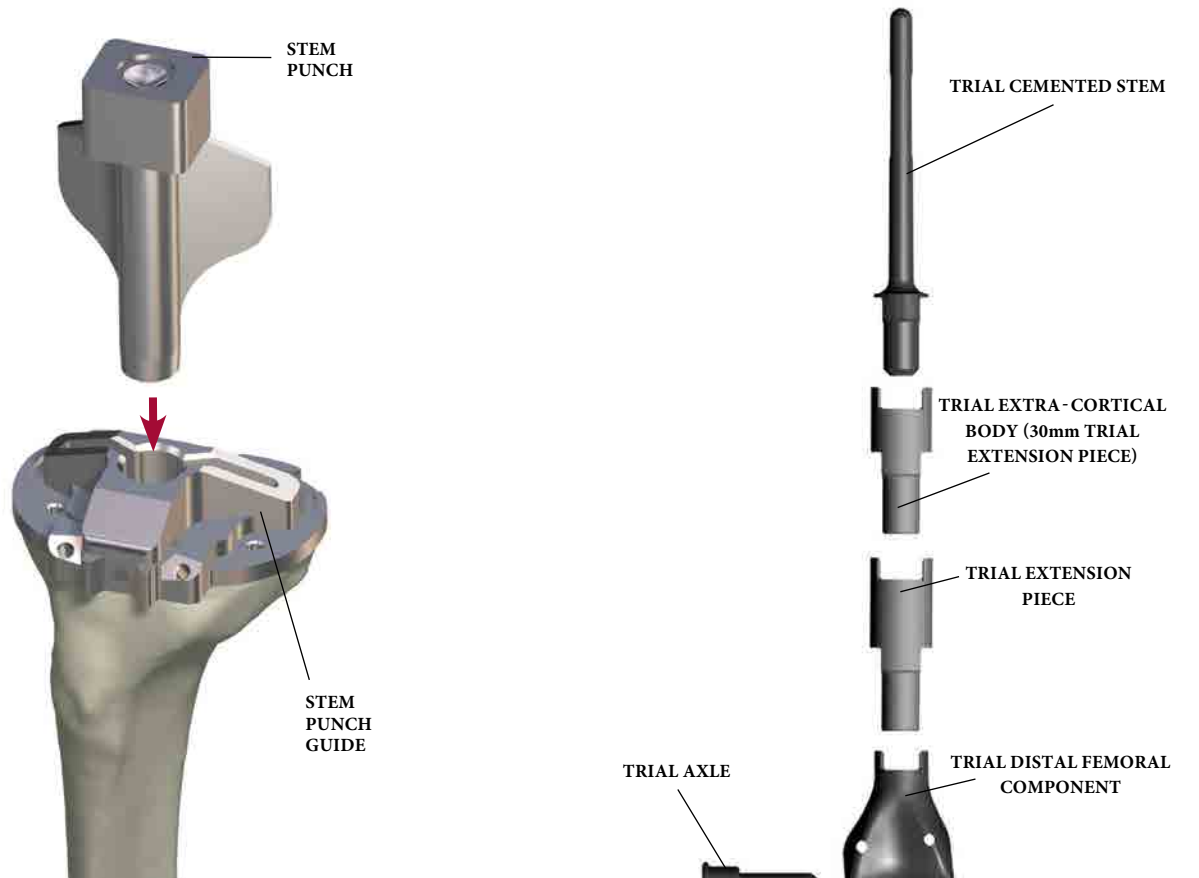

Figure 10

For the Keel Baseplate, the **Stem Punch Guide** is placed in the corresponding holes in the Tibial Template (**Figure 10**). The **Stem Punch** is impacted through the cut-out on the guide.

Femoral and Tibial Trial Assembly

All trial components required for the trial reduction are shown in **Figure 11**.

NOTE: The 30mm Trial Extension Piece also functions as the Trial Extra-Cortical Body (see **Figure 11**). Together with the Trial Cemented Stem, it forms the Trial Stem with extra-cortical porous-coated body.

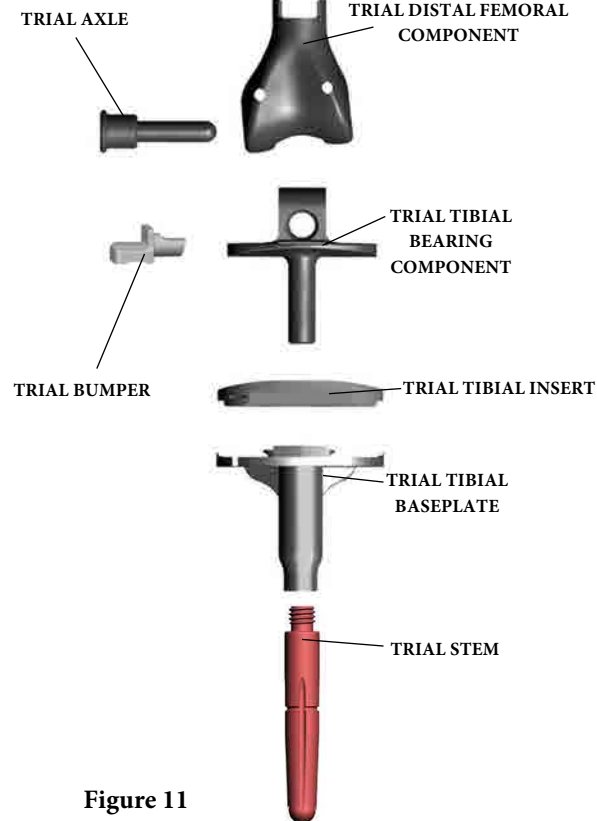

Figure 11

6633-9-86X

Stem Punch Guide

Tibial Prep
Tray R8



6633-7-3XX

Stem Punch

Tibial Prep
Tray R8





Figure 12

Trial Reduction

The purpose of the trial reduction is to determine the ease of insertion of the femoral and tibial components prior to cementing, and to determine whether the length of the prosthesis is appropriate (**Figure 12**). If the prosthesis is too long, too much tension will be placed upon the neurovascular structures when the knee is extended. In addition, the extensor mechanism will be tight, causing loss of flexion and difficulty in closing the soft tissues.

To determine the appropriate length, one must extend the knee and monitor the distal pulse with the trial prosthesis in place.

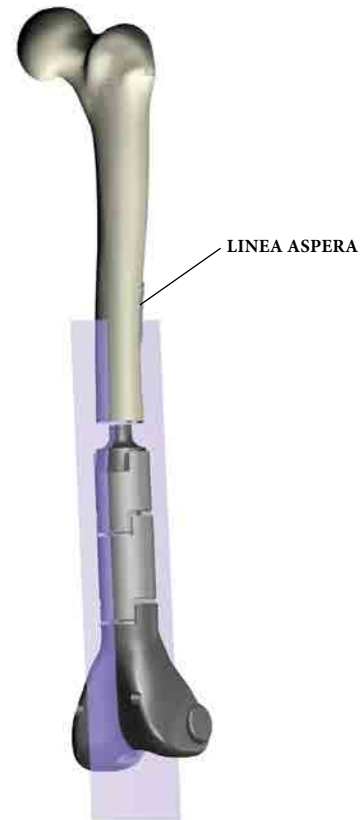

Figure 13

Insert the **MRH Trial Tibial Baseplate** into the tibia, and impact it using the **MRH Tibial Impactor/Extractor** until it is flush with the tibial osteotomy.

Construct the Trial Femoral Prosthesis by joining the **Trial Cemented Stem** with the **Trial Extension Piece**, if required, and with the **Trial Distal Femoral Component**.

Insert the stem of the trial femoral assembly into the femur. As a guide to rotational orientation, align the rotational alignment mark on the femoral stem segment with the rotational reference mark previously made on the anterior cortex of the femur (**Figure 13**).

6481-3-41X

Trial Tibial Baseplate



MRH Instrument Tray H1

6481-8-008

Tibial Impactor/Extractor



MRH Instrument Tray H1

6486-3-XXX

Trial Cemented Stem



GMRS Tray No: 4A/4B

6496-6-XXX

Trial Extension Piece



GMRS Tray No: 1A/1B

6496-2-0XX

Trial Distal Femoral Component



GMRS Tray No: 1A

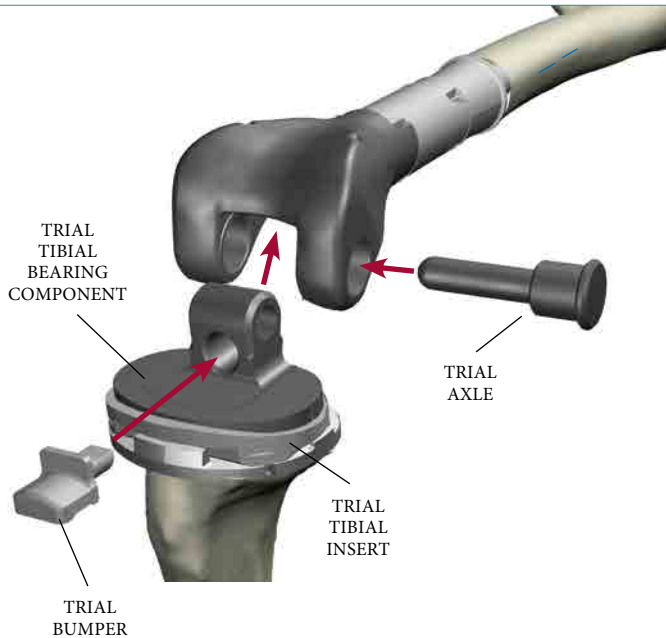

Figure 14

Insert the correct **Trial Tibial Insert** into the MRH Trial Baseplate. Insert the **Trial Tibial Bearing Component** into the Trial Baseplate assembly. Bring the Trial Tibial Bearing Component up between the femoral condyles and insert the **Trial Axle**. Then insert the **Trial Bumper** through the anterior hole of the Trial Tibial Bearing Component (**Figure 14**).

Manipulating the knee through its range of motion may be used to determine the appropriate rotation of the femoral component. If the evaluation identifies a rotation different than that already marked, an additional mark should be made or the rotation should be noted relative to the existing mark. Slight external rotation may aid in patellar tracking.

Hold the trial femoral assembly in one hand to prevent rotation and extend the leg fully. Palpate the femoral vessels to determine the status of the pulse. If the pulse is diminished, flex the knee to determine if it increases. This will indicate the need for either modifying the length of the prosthesis or for removing additional bone from the distal femur or proximal tibia.

SURGICAL TIP: As an aid in checking leg length, the distance between the leg-length reference marks on the tibia and femur can now be rechecked (see **Figure 1c**, page 8)

If it is determined that the prosthetic construct is too long, the length of the distal femoral bone resected should be rechecked against the length of the assembled prosthesis. If the prosthesis is too long, either additional bone can be removed from the femur, the length of the prosthesis can be adjusted, or a thinner insert can be evaluated.

If the surgeon feels that removing additional bone from the femur or shortening the femoral prosthesis will have a negative effect on patellar tracking, additional bone must be removed from the tibial side.

A final test of the range of motion of the knee with the patella tracking in place is then performed. If the patella will be resurfaced, this must be done with the patellar trial in place. A full range of motion should be obtained. Note whether the capsular mechanism can be closed. These factors, taken together, will determine the adequacy of the length of the resection.

The two most important factors in accepting final length are:

1. Proper Patellar tracking
2. Distal pulses

The decision can now be made if a gastrocnemius flap or muscle transfer will be required, dependent upon the presence or absence of the capsule or portions of the quadriceps.

6481-3-XXX

Trial Tibial Insert



MRH Instrument Tray No: 2

6496-3-602

Trial Standard Tibial Bearing Component



Tray No: 2

6496-2-115

Trial Axle



GMRS Tray No: 1A

6496-2-130/133

Trial Bumper



GMRS Tray No: 1A



Figure 15

Assembly of the Tibial Stem Implant

To attach a CoCr Stem, or 80mm titanium fluted stem to the implant, hand tighten the stem into the Tibial Stem Boss as far as possible. Attach the **All-in-one Wrench** to the **Torque Wrench**, insert the male hex tip of the wrench into the hex recess on the Stem. Attach the **Counter Wrench** to the Tibial Baseplate and tighten to 120in/lbs – 180in/lbs (**Figure 15**).

NOTE: A Stem of at least 80mm should be used on the Tibial Baseplates.



Figure 16

Titanium Tri-Fluted Stem Option

When using a 155mm Titanium Fluted Stem, the Tri-Fluted part of the All-in-one Wrench must be used to apply the final torque to the implant. This adapter is attached to the Torque Wrench and slid into the slots of the Stem until it has bottomed out on the implant. The Stem must be tightened to the final locking torque of 120in/lbs – 180in/lbs (**Figure 16**).

8200-0105

All-in-one Wrench

MRH Instrument
Tray H2



6633-9-986

Torque Wrench

MRH Instrument
Tray H2



6632-7-010

Counter Wrench

Tibial Prep Tray R8



Assembly of the Femoral Prosthesis

The femoral prosthesis consists of the Stem, Extension Piece (when needed based on the length of the reconstruction), and the Distal Femoral Component (Figure 17). Check that the correct side (left or right) and size (standard or small) for the Distal Femoral Component and the correct sizes of all components have been chosen before assembly. If necessary, it is acceptable to stack two Extension Pieces to construct the necessary length. The instruments used for the assembly of the prosthesis are the Impaction Tube, the appropriate Impaction Tube Insert, the 5-in-1 Impactor and the Impaction Block, if necessary, along with a Mallet.

NOTE: If the small Distal Femoral Component is selected, the small Femoral Bushings (6495-2-105) and the small Axle (6495-2-115) must be used.

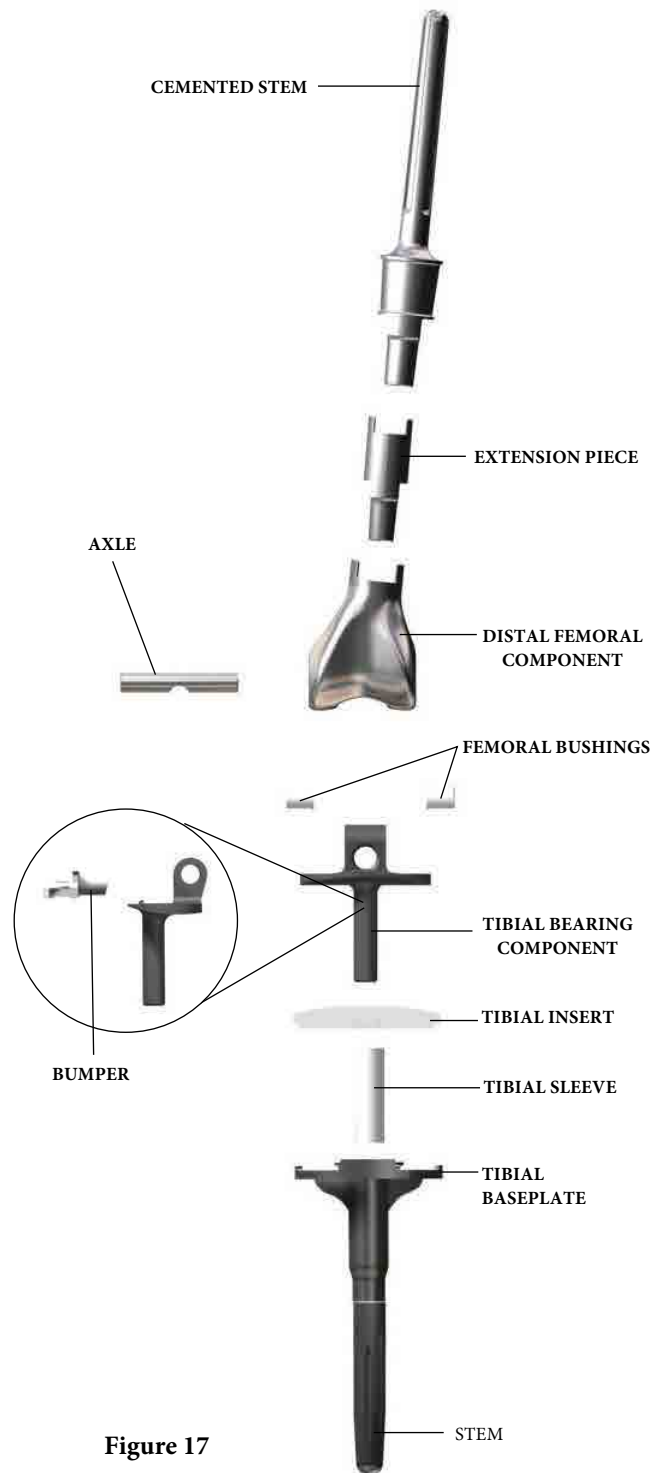

Figure 17

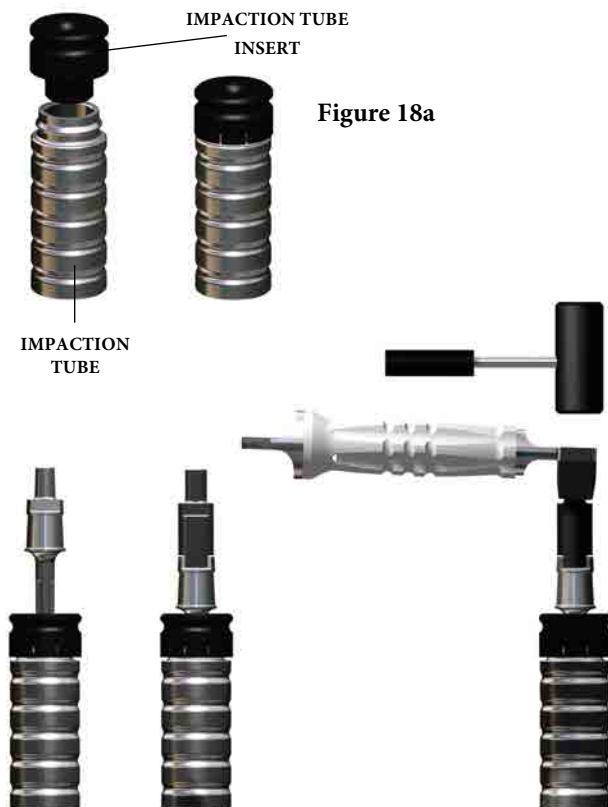

Figure 18a

Figure 18b

The **Impaction Tube Insert** corresponding to the stem diameter is assembled to the **Impaction Tube** (**Figure 18a**).

The Extension Piece, if required, and the cemented Stem are assembled first. The cemented Stem is placed into the Impaction Tube and the Extension Piece is mated with it. The **5-in-1 Impactor** is placed over the taper of the Extension Piece and impacted with several swift blows of a heavy **Mallet** to lock the tapers (**Figure 18b**).

Next, the Stem/Extension piece construct is assembled to the Distal Femoral Component. Place the Distal Femoral Component onto the Extension Piece or Stem. The 5-in-1 Impactor is inserted between the condyles of the Distal Femoral Component so that its handle is parallel to the axis of the bushing holes and impacted with a Mallet (**Figure 19a**).

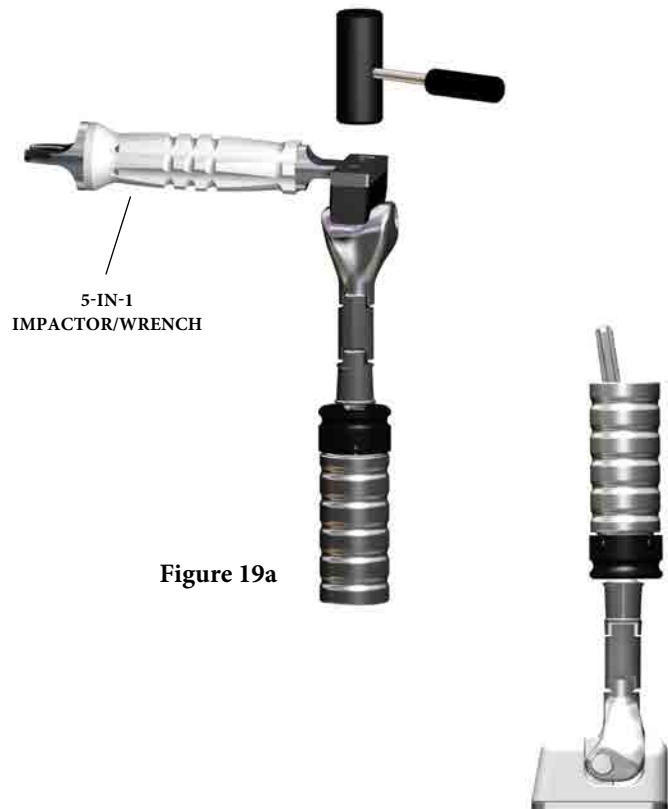

Figure 19a

Figure 19b

If a 203mm long curved cemented Stem is to be implanted, the Distal Femoral Component is inserted into the **Impaction Support Block**. An Extension Piece, if required, is inserted into the Distal Femoral Component and then the appropriate diameter cemented Stem is inserted into the Extension Piece or Distal Femoral Component. Verify that the bow of the cemented Stem curves towards the posterior of the Distal Femoral Component. The Impaction Tube is inverted and placed over the cemented Stem and impacted with several blows of a heavy mallet, or by sliding the Impaction Tube over the stem like a Slap Hammer (**Figure 19b**).

<p>6496-9-065/066 Impaction Tube Insert GMRS Tray No: 4A</p> 	<p>6496-9-053 Impaction Tube GMRS Tray No: 4A</p> 	<p>6496-9-063 5-in-1 Impactor GMRS Tray No: 3</p> 	<p>6496-9-064 Impaction Support Block GMRS Tray No: 1A</p> 
---	--	--	---



Figure 20

Implantation and Orientation of the Tibial and Femoral Prostheses

To implant the tibial baseplate, the medullary canal is irrigated and dried. Surgical bone cement is applied to the proximal tibia resection and the underside of the baseplate. The Tibial Impactor/Extractor (**Figure 20**) is used to impact the Tibial Baseplate to its full depth, ensuring the Keel engages in the prepared bone. The femoral canal is thoroughly irrigated. A cement restrictor is placed at the appropriate depth. This depth is checked by inserting the trial femoral stem and verifying complete seating. The femoral canal is again irrigated and dried. The soft tissues, especially those that are near the neurovascular structures, are protected and packed off with wet lap pads. Bone cement is mixed and injected into the canal to ensure proper filling of the canal. Some cement is then placed around the stem of the prosthesis.

SURGICAL TIP: If a stem centralizer is not being used, plug the hole in the stem with bone cement.

The prosthesis is then inserted into the femoral canal until the stem seat is flush with the host bone at the osteotomy site. Excess cement is removed from around the prosthesis. Care is taken to prevent cement from getting into the Extra-Medullary porous-coated section. It is firmly held in place at the rotational orientation determined by the trial reduction while the cement cures.



Figure 21

With the Femoral Prosthesis and Tibial Baseplate implanted, it is possible to use the Trial Axle with the Trial Tibial Bearing Component, the Trial Bumper Insert and Trial Tibial Insert to verify that the appropriate motion, stability and patellar tracking have been achieved. With the knee in full extension this also assists in loading the femoral and tibial baseplate components while the cement is curing to provide an optimal bond between implant and bone (**Figure 21**).

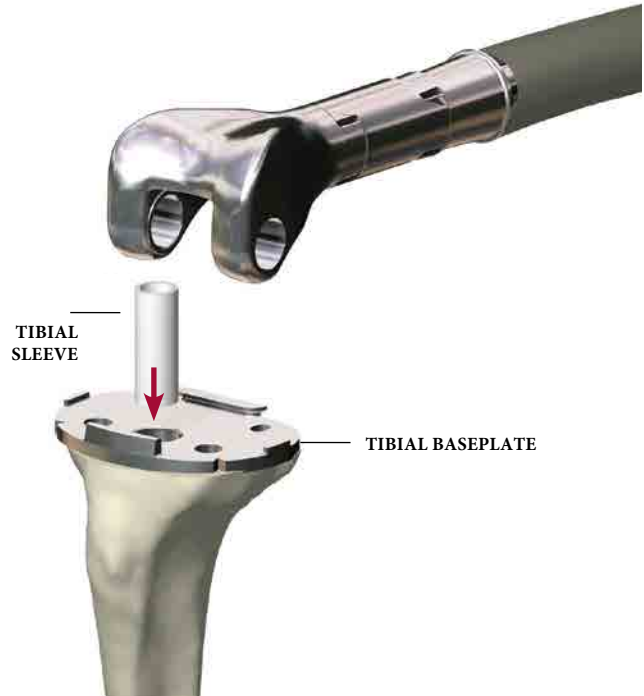

Figure 22

Final Implant Assembly

To complete the assembly of the final implant components, insert the Tibial Sleeve into the Tibial Baseplate until it is flush with the surface (**Figure 22**).

Figure 23a

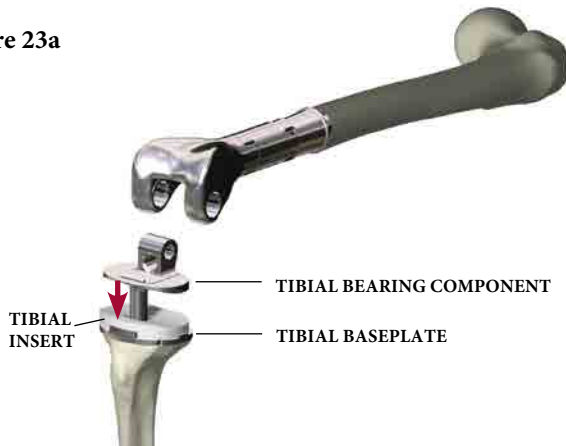

Figure 23b

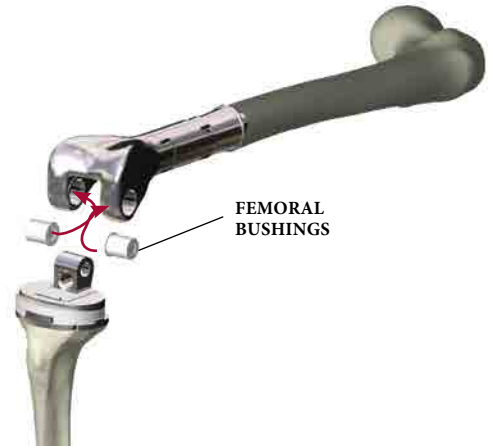
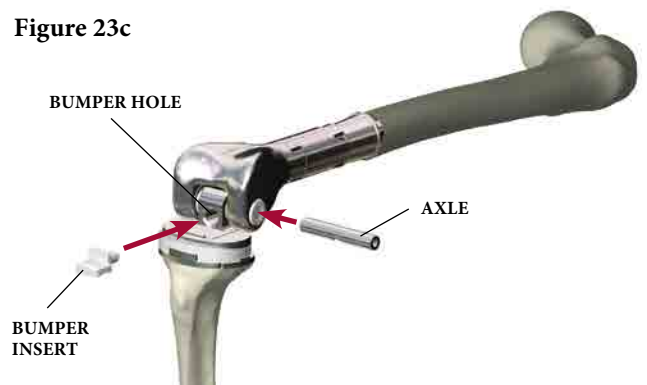

Figure 23c



There are two sizes of Tibial Insert, Small 1/ Small 2 and Medium 2/ Large 2, which fit with the corresponding Tibial Baseplates. They both come in 5 different thicknesses of 10mm, 13mm, 16mm, 20mm and 24mm.

Snap-in the appropriate thickness Tibial Insert, chosen at the trialing stage and drop in the Tibial Bearing Component (Figure 23a).

Insert the two Femoral Bushings into the Femoral Prosthesis so that the flanges are inside the intercondylar cut-out (Figure 23b).

Line up the Tibial Bearing Component with the holes of the Femoral Component Bushings and slide the implant Axle into the assembly (Figure 23c) until the “recess” in the Axle can be seen through the Tibial Bearing Component from the front. Twist the Axle so that the “recess” is inferior. The grooves on the end of the axle which engage into the Axle Introducer Handle are a helpful indicator in aligning the Axle.

With the Axle correctly oriented the Bumper can now be inserted. This should be impacted into the Tibial Bearing Component until it is flush with the hinge housing and has cleared the locking tab on the Tibial Bearing Component (Figure 23c).

NOTE: With the Bumper inserted, the axle should not be further rotated.

The Bumper implant is available in two options, neutral and 3° flexion.

If a patellar component is used, it is implanted by applying sufficient amount of bone cement to the patellar implant and bone. Cement should be applied to both the bone surface and the back of the patellar implant, including the pocket.

SURGICAL TIP: Application of cement in a low-viscosity state will allow the implant to fully seat and facilitate inter-digitation of cement into bone.

GMRS® Distal Femoral Surgical Protocol

Appendices

Appendix I

Establishing the Depth of the Tibial Cut **28**

Appendix II

Tibial Preparation for the
All-Poly Tibial Component **40**

Appendix III

Taper Disassembly **46**

Appendix I

Establishing the Depth of the Tibial Cut

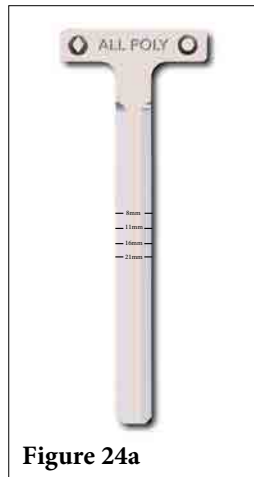

Figure 24a

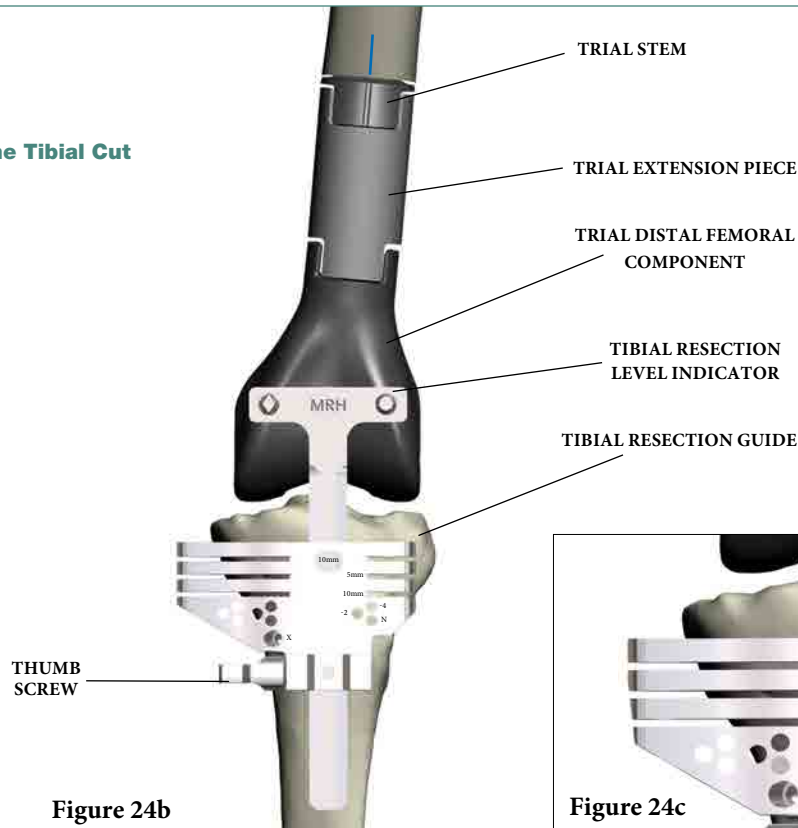

Figure 24b

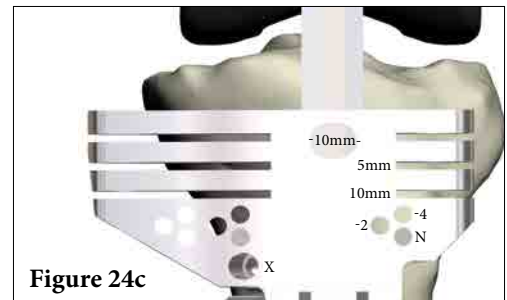

Figure 24c

Option A: Femoral Referencing Method

Construct the Trial Femoral prosthesis by joining the **Trial Stem** with the **Trial Extension Piece**, if required, and the **Trial Distal Femoral Component**.

With the trial femoral construct in place, the **Tibial Resection Level Indicator** is inserted into the Trial Distal Femoral Component. The Tibial Resection Level Indicator (**Figure 24a**) is two-sided. The first side marked “MRH” applies when MRH Tibial Baseplates are used. When the Kinematic Rotating Hinge All-Poly Tibial Components are used, the second side marked “ALL POLY” applies. With both MRH Tibial Components and All-Poly Tibial Components, the Tibial Resection Level Indicator denotes the proper tibial resection level through etched markings on the resection level indicator shaft. The tibia should be held out to length at the previously determined marking (see **Figure 1c** on *page 8*).

The **Tibial Resection Guide** can be lined up to that mark and held in place by tightening the thumbscrew (**Figure 24b**). The **Alignment Handle** can be assembled to the Tibial Resection Guide. **Long Alignment Pins** are then inserted through the handle to evaluate M/L and A/P alignment. Once alignment and resection level have been determined, pin the Tibial Resection Guide to the tibia using $1/8$ ” pins through the ‘N’ holes.

Begin by setting the Tibial Resection Guide for the thinnest Tibial Insert (**Figure 24c**). The Tibial Insert thicknesses are: 10mm, 13mm, 16mm, 20mm and 24mm. If the resection level will not remove any bone, the Resection Guide can be set for a thicker Tibial Insert. Be certain not to place too much tension on the tibia during distraction.

If the surgeon feels that too much tibial bone must be removed using the thinnest Tibial Insert, additional bone can be removed from the femur. The level of the patella is checked in reference to the prosthesis to ensure proper patellar tracking.



<p>6496-2-0XX Trial Distal Femoral Component GMRS Tray No: 1A</p> 	<p>6496-9-057 Tibial Resection Level Indicator GMRS Tray No: 1A</p> 	<p>6496-9-051/052 Tibial Resection Guide GMRS Tray No: 8A</p> 	<p>6633-7-250 Alignment Handle GMRS Tray No: 8B</p> 	<p>6838-7-230 Long Alignment Pin GMRS Tray No: 8B</p> 
--	--	--	--	--



Figure 25

Remove the Femoral Trial construct and the Tibial Resection Level Indicator by unlocking the thumb screw.

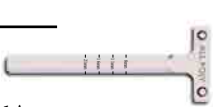
Proximal Tibial Resection

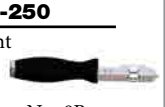
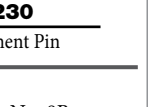
Slide the Tibial Resection Guide posteriorly until it comes in contact with the anterior tibia.

Placing a 1/8" Drill Pin through the "X" pin hole will further secure the Resection Guide to the tibia.

The Alignment Handle may be used with an Alignment Rod, referencing the same landmarks as outlined previously to verify proper alignment.

Resect the tibial plateau using a .050" (1.27mm) Saw Blade (Figure 25).

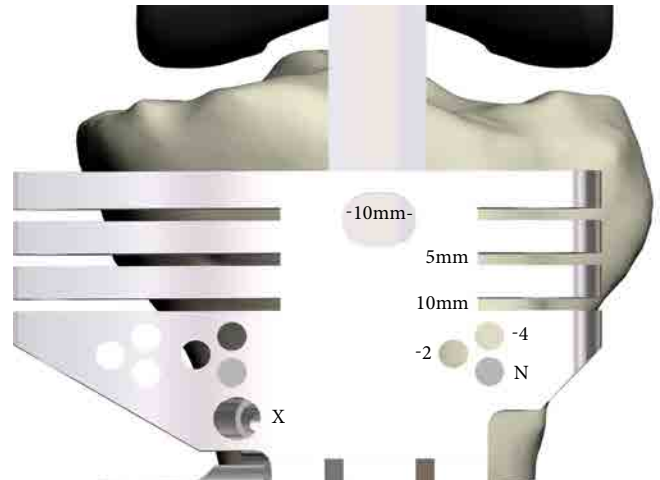

Figure 26

If desired, 2mm or 4mm of additional bone may be resected by repositioning the guide over the pins through the -2 or -4 holes, respectively (Figure 26).

NOTE: If the "X" Pin hole is used, this pin must be removed prior to repositioning the Tibial Resection Guide.

The Tibial Resection Guide is removed by first removing the "X" pin, then sliding the guide off over the two 1/8" Drill Pins and finally removing the pins with the Pin Puller.

NOTE: The 5mm and 10mm slots can be used in revision or trauma cases where bone loss or fracture respectively necessitates the use of half or full tibial augments.

6633-7-605

Pin Puller

GMRS Tray No: 8B



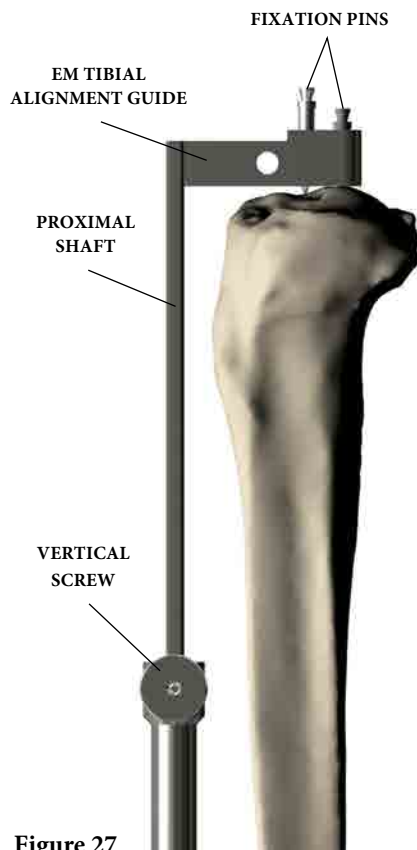

Figure 27

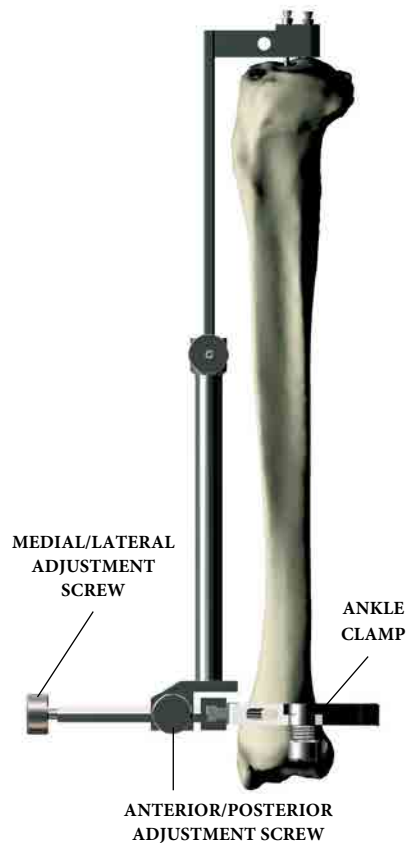

Figure 28

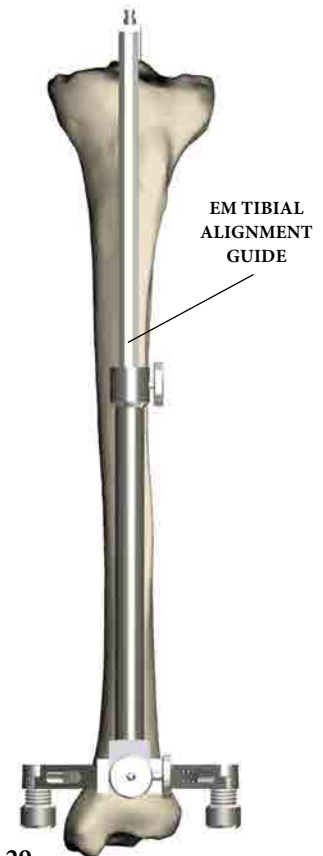

Figure 29

Option B: Extra-Medullary Referencing

With the knee flexed, place the **EM Tibial Alignment Guide** on the tibial shaft. Place the **Ankle Clamp** around the distal tibia just above the malleoli.

Place the Fixation Pins of the instrument over the tibial eminence. There should be a finger's breadth clearance between the proximal shaft of the Alignment Guide and the anterior cortex when the Fixation Pins are positioned properly. Center the Proximal Fixation Pins over the tibial eminence and tap in the most posterior pin first to fix the anterior/posterior location of the head. Rotation is now adjusted and then set by anchoring the second pin. Tighten the vertical screw to secure the proximal shaft of the guide (**Figure 27**).

Axial alignment is achieved when the vertical shaft of the instrument parallels the long axis of the tibia in both the anterior/posterior and medial/lateral planes (**Figure 28**, **Figure 29**).

8000-1056

EM Tibial Alignment Guide

GMRS Tray No: 8A



8000-1040

Ankle Clamp

GMRS Tray No: 8A





Figure 30

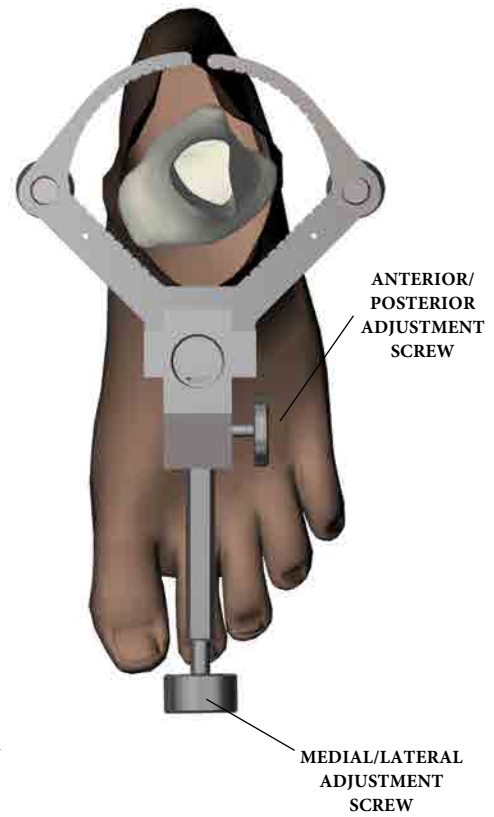

Figure 31

Landmarks used to obtain correct axial alignment and rotation are:

1. Tibial Tubercle – The alignment rod usually lies over the medial third of the tibial tubercle.
2. Second Metatarsal – The second metatarsal generally is in line with the center of the ankle (**Figure 30**).

Once axial alignment is established, tighten the anterior/posterior and medial/lateral adjustment thumbscrews (**Figure 31**).

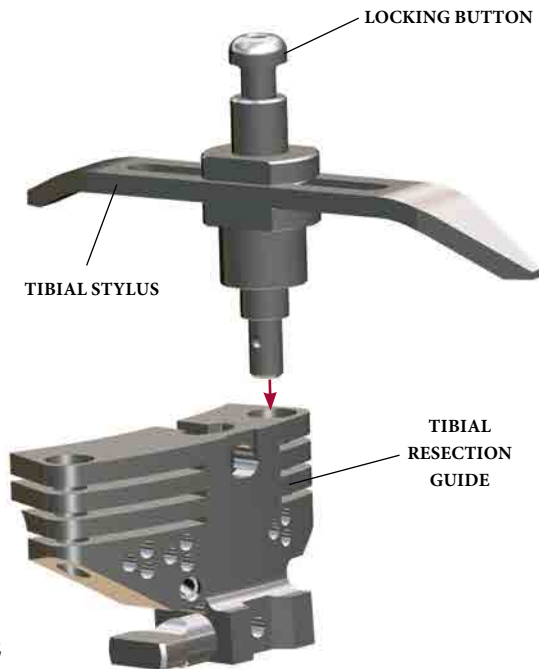

Figure 32



Figure 33

Tibial Resection Level

Assemble the **Tibial Stylus** to the Tibial Resection Guide by depressing the locking button on the top of the Tibial Stylus, inserting the stylus into either the medial or lateral holes on the top of the Tibial Resection Guide and releasing the button to lock the Stylus into place (**Figure 32**).

The Stylus has two depth setting options for the Tibial Resection Guide, depending on which end of the stylus is used, 12mm or 18mm. An 18mm resection is required from the tibia if the distal most aspect of the femoral replacement is placed at the same level of the original anatomy. Typically, a 12mm resection would be preferred, which requires resecting an additional 6mm from the femur. The level of the patella should be checked to ensure proper patellar position.

Attach the Tibial Resection Guide/Tibial Stylus assembly to the External Tibial Alignment Guide by sliding it over the top of the proximal shaft, adjusting the stylus to reference the desired point on the tibial plateau (**Figure 33**).

6496-9-068

Tibial Stylus

GMRS Tray No: 8A



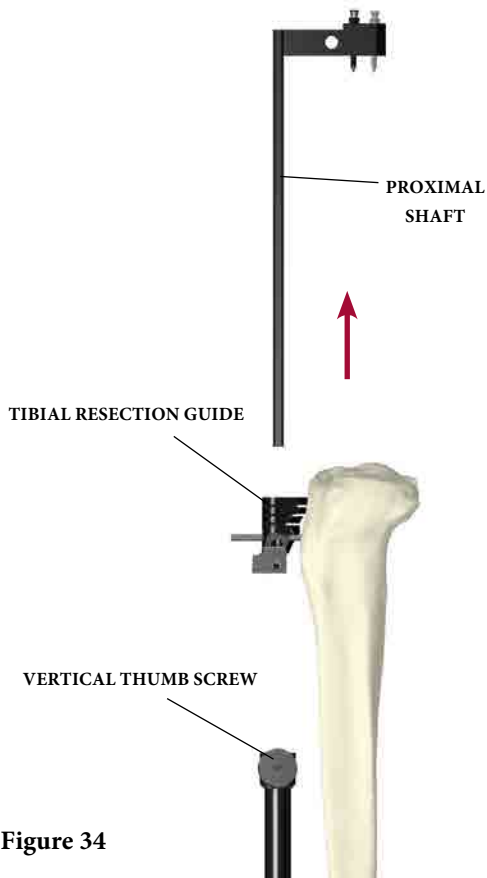

Figure 34

Proximal Tibial Resection

Secure the Tibial Resection Guide to the proximal tibia using two 1/8" Drill Pins, drilling through the "N" holes.

Loosen the thumbscrew that holds the Tibial Resection Guide to the External Tibial Alignment Guide.

Loosen the vertical adjustment thumbscrew on the shaft of the Alignment Guide.

Extract the two headed Fixation Pins on the top of the Alignment Guide from the proximal tibia.

Remove the proximal shaft of the Alignment Guide by sliding it up through the top of the Resection Guide (Figure 34).

Slide the Tibial Resection Guide posteriorly until it comes in contact with the anterior tibia.

Placing a 1/8" Drill Pin through the "X" pin hole will further secure the Resection Guide to the tibia.

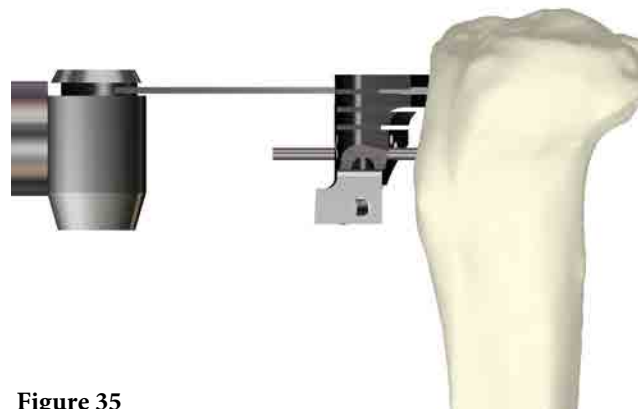

Figure 35

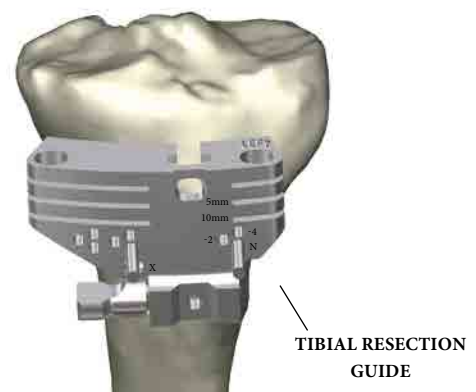

Figure 36

The Alignment Handle may be used with an Alignment Rod, referencing the same landmarks as outlined previously to verify proper alignment.

Resect the plateau using a .050" (1.27mm) Saw Blade (Figure 35).

If desired, 2mm or 4mm of additional bone may be resected by repositioning the guide over the pins through the -2 or -4 holes respectively (Figure 36).

NOTE: If the "X" Pin hole is used, this pin must be removed prior to repositioning the Tibial Resection Guide.

The Tibial Resection Guide is removed by first removing the "X" pin, then sliding the guide off over the two 1/8" drill pins and then removing the pins with the Pin Puller.

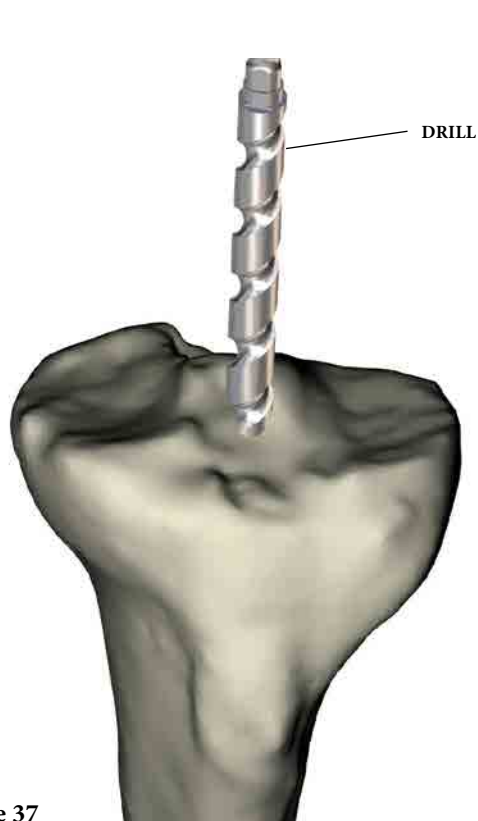

Figure 37

Option C: Intra-Medullary Referencing

Using the $\frac{3}{8}$ " **IM Drill** an entry hole is prepared in the location determined by the pre-operative X-rays, or just anterior to the ACL insertion. (**Figure 37**). Alternatively, a suitably sized Tibial Template can be used to locate the center of the cavity to be prepared for the Stem.

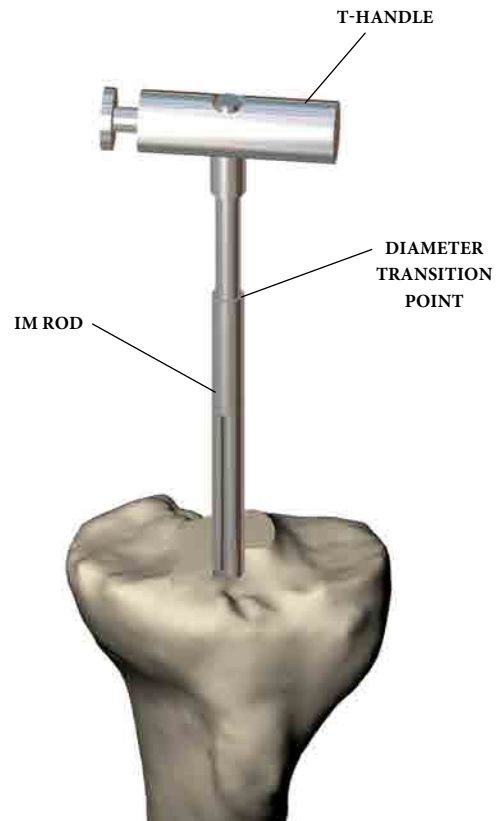



Figure 38

Attach the pre-determined diameter **IM Rod** ($\frac{1}{4}$ ", $\frac{5}{16}$ ", or $\frac{3}{8}$ ") to the **T-Handle** by depressing the button, inserting the IM Rod fitting, and releasing the button to lock into place. Pre-operative X-ray templating will aid in the determination of the IM Rod diameter. Introduce the IM Rod into the entry hole and gradually advance it down the Intra-Medullary canal (**Figure 38**).

Several steps may be taken to avoid an increase in Intra-Medullary pressure:

- A. Advance the IM Rod slowly;
- B. Rotate the IM Rod within the canal during advancement;
- C. Apply suction to the fitting on the end of the cannulated IM Rod.
- D. Use next smallest IM Rod.

<p>7650-1033 $\frac{3}{8}$" IM Drill GMRS Tray No: 8A</p>	
---	---

<p>7650-1024/64/65 IM Rod GMRS Tray No: 8A</p>	
---	--

<p>7650-1026 T-Handle GMRS Tray No: 8A</p>	
---	---

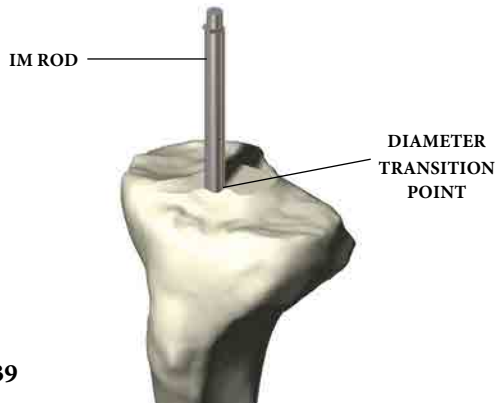

Figure 39

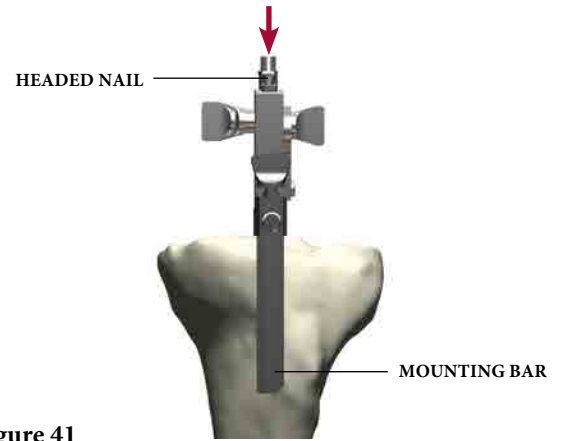

Figure 41

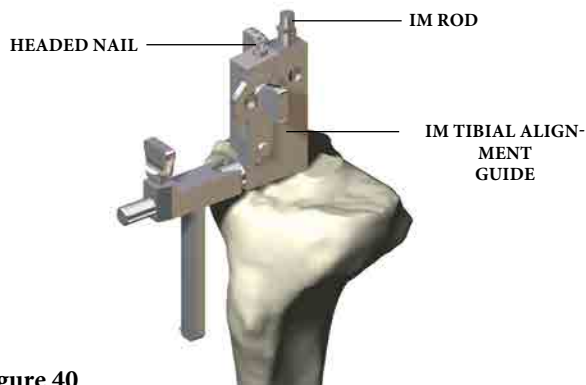

Figure 40

The proximal portion of both the $\frac{3}{8}$ " and $\frac{1}{4}$ " diameter IM Rods changes to $\frac{5}{16}$ " in diameter. It is necessary to insert those rods so that the diameter transition point is within the Intra-Medullary canal. The $\frac{5}{16}$ " diameter IM Rod may be inserted to any depth up to the scribe mark on the proximal shaft. Once the IM Rod is positioned, remove the T-Handle (Figure 39).

Intra-operative X-Rays may be obtained to confirm accurate position of the rod in the canal.

Slide the **IM Tibial Alignment Guide** over the Alignment Rod (Figure 40).

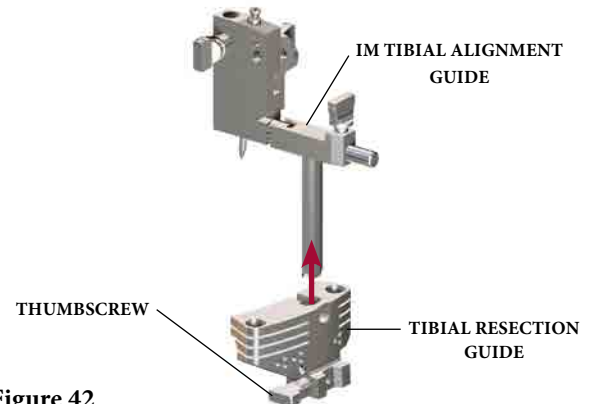

Figure 42

Rotational Alignment

With the body of the IM Tibial Alignment Guide resting on the proximal tibia, alignment is achieved by rotating the instrument about the IM Rod so that the tibial tubercle appears slightly lateral to the vertical mounting bar. The Heated Nail is impacted, fixing rotational alignment (Figure 41).

Assemble the appropriate Tibial Resection Guide to the IM Tibial Alignment Guide by sliding the Tibial Resection Guide onto the mounting bar of the Alignment Guide and tightening the thumbscrew on the Resection Guide (Figure 42).

<p>8000-1066</p> <p>IM Tibial Alignment Guide</p> <p>GMRS Tray No: 8A</p>	
--	--

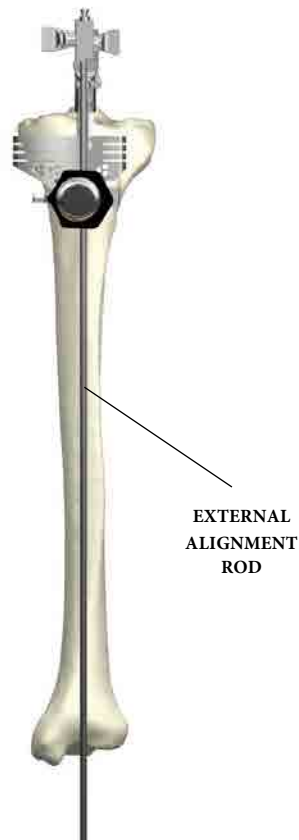
**Figure 43**

Attach the Alignment Handle to the Resection Guide, and slide a Long Alignment Rod into the Alignment Handle. When proper varus/valgus alignment is attained, the pin should be centered over the ankle (**Figure 43**).

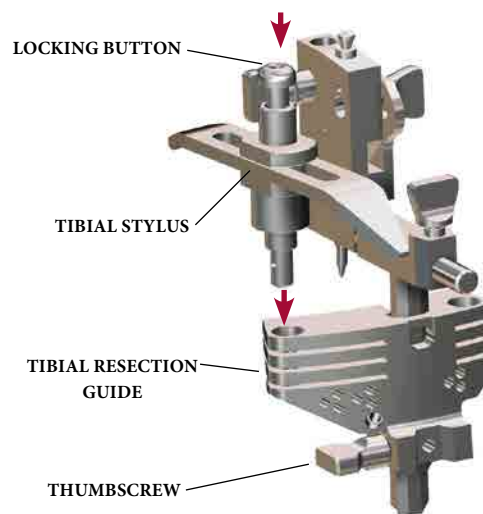
**Figure 44**

Assemble the Tibial Stylus to the Tibial Resection Guide by depressing the button on the top of the Tibial Stylus, inserting the stylus into either the medial or lateral hole on the top of the Tibial Resection Guide, and releasing the button to lock the stylus into place (**Figure 44**).

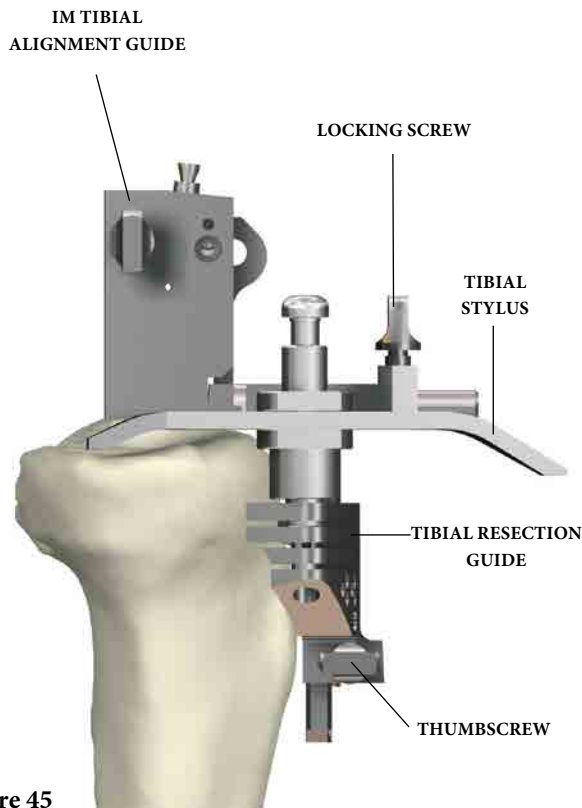

Figure 45

Loosen the thumbscrew and position the Tibial Resection Guide/Tibial Stylus Assembly to reference the desired point on the tibial plateau. Secure the Tibial Resection Guide/Tibial Stylus Assembly to the IM Tibial Alignment Guide by retightening the thumbscrew (**Figure 45**).



Figure 46

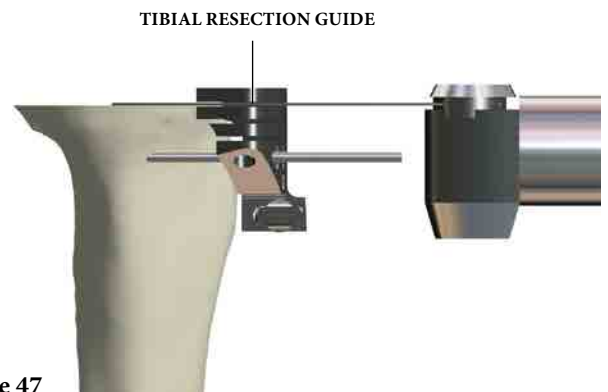

Figure 47

Proximal Tibial Resection

Once the resection level is established, secure the Tibial Resection Guide to the anterior tibia using the 1/8" Drill Pins, drilling through the "N" holes.

Remove the Tibial Stylus by depressing the button and pulling the stylus out.

Release the IM Tibial Alignment Guide from the Tibial Resection Guide by loosening the thumbscrew on the Resection Guide. Re-attach the T-Handle to the IM Rod and extract both the IM Rod and IM Tibial Alignment Guide together, leaving the Tibial Resection Guide pinned in place.

Pinning through the "X" Pin Hole will further secure the Tibial Resection Guide to the tibia (**Figure 46**).

Resect the tibial plateau through the most proximal slot in the Tibial Resection Guide. Use of a .050" (1.27mm) Saw Blade is recommended for an accurate resection (**Figure 47**).

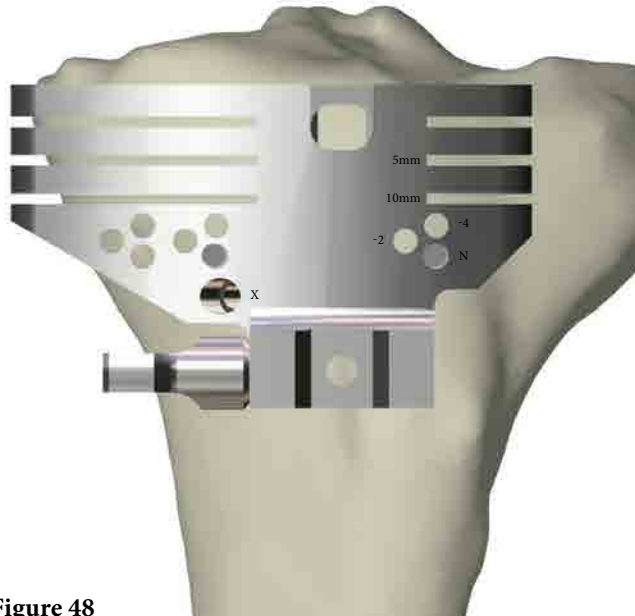

Figure 48

Additional bone may be resected by repositioning the Tibial Resection Guide over the pins in the -2 or -4 holes to resect an additional 2mm or 4mm of bone, respectively (Figure 48).

NOTE: If the “X” Pin hole is used, this pin must be removed prior to repositioning the Tibial Resection Guide.

The Tibial Resection Guide is removed by first removing the ‘X’ Pin, then sliding the Block off over the two 1/8” drill pins and then removing the pins with the Pin Puller.

NOTE: The 5mm and 10mm slots can be used in revision or trauma cases where bone loss or fracture respectively necessitates the use of half or full tibial augments.

APPENDIX II

**Tibial Preparation for the
All-Poly Tibial Component**

Appendix II

Tibial Preparation for the All-Poly Tibial Component

The proximal tibial cut for the All-Poly Tibial Component is a neutral cut, i.e. classical alignment with no posterior slope.

The All-Poly Tibial component comes in five sizes: XSML, SML, MED, LRG and XLRG. Each size component has four thicknesses: 8mm, 11mm, 16mm and 21mm.

Establishing the depth of the tibial cut for the All-Poly Tibial components is the same as described in Appendix I. With regard to the Femoral Referencing Method (Option A), the Tibial Resection Level Indicator is used with the side marked "ALL POLY".

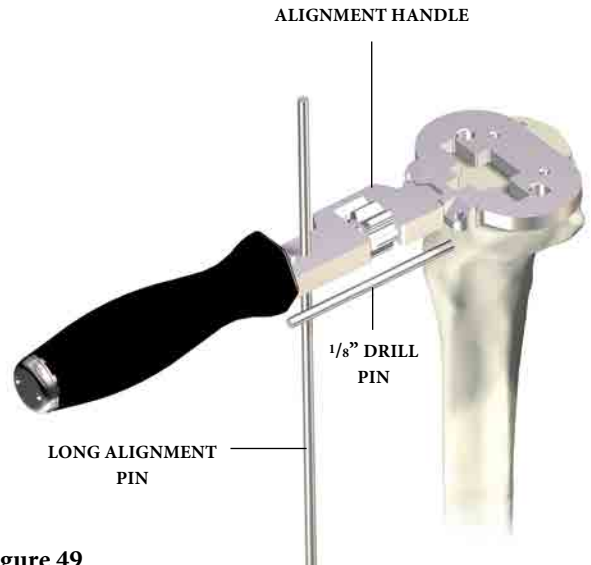





Figure 49

Verifying Alignment

Select the appropriate **All Poly Tibial Template** and lock it onto the **Tibial Alignment Handle**.

The appropriate size Template will achieve cortical support around the periphery of the template.

The long **Alignment Pin** assembled with the Alignment Handle verifies rotational, Varus/Valgus, and flexion/extension alignment (**Figure 49**).

<p>6737-8-315/320/325/330/335 All Poly Tibial Template</p>  <p>GMRS Tray No: 8A</p>	<p>6633-7-250 Alignment Handle</p>  <p>GMRS Tray No: 8B</p>	<p>6838-7-2X0 Alignment Pin</p>  <p>GMRS Tray No: 8B</p>
---	---	--

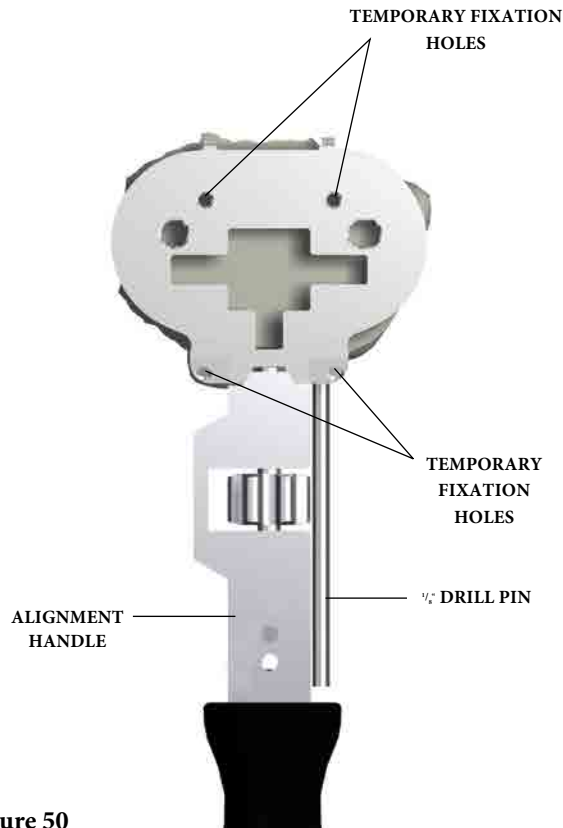

Figure 50

Rotational alignment is correct when the drill bit placed in a hole from the tibial resection step is parallel to the handle (Figure 50). Varus/Valgus and flexion/extension is verified with a Long Alignment Pin.

Holes are located on the anterior face and posterior surface of the Template. **Headed Nails** or drills through these holes may be used to temporarily fix the Template.

NOTE: It is important that the correct size be selected to fully support the All-Poly Tibial Component around the periphery with cortical bone.

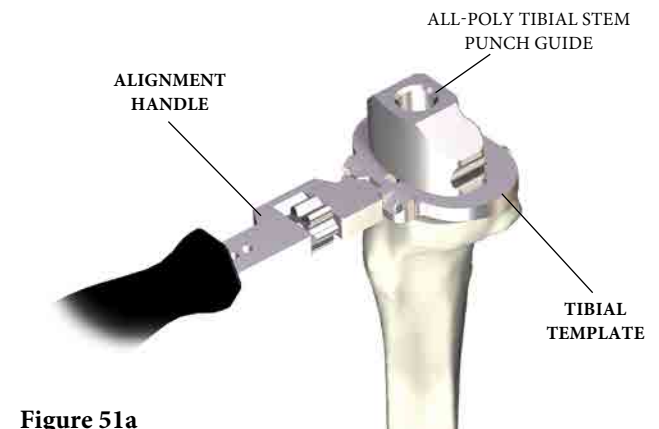

Figure 51a

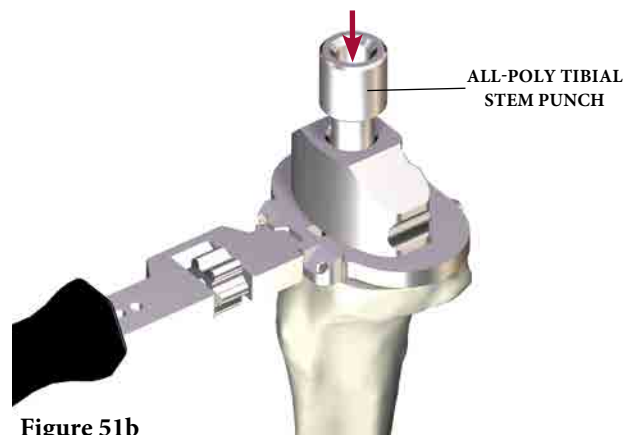

Figure 51b

Round Stem Punch

To begin preparation for the Kinematic Rotating Hinge All-Poly Tibial Component, place the **Stem Punch Guide** (Figure 51a) on the Tibial Template. Insert the **Stem Punch** into the guide and slowly impact the punch until it is flush with the guide (Figure 51b).

6633-7-600/615

Headed Nails



GMRS Tray No: 8A

6737-8-340

Stem Punch Guide



GMRS Tray No: 8B

6737-8-345

Stem Punch



GMRS Tray No: 8B

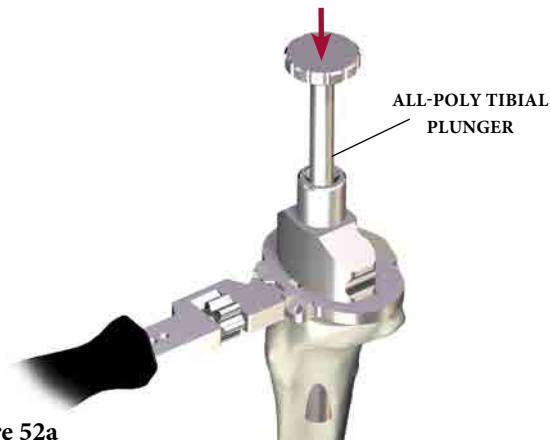

Figure 52a

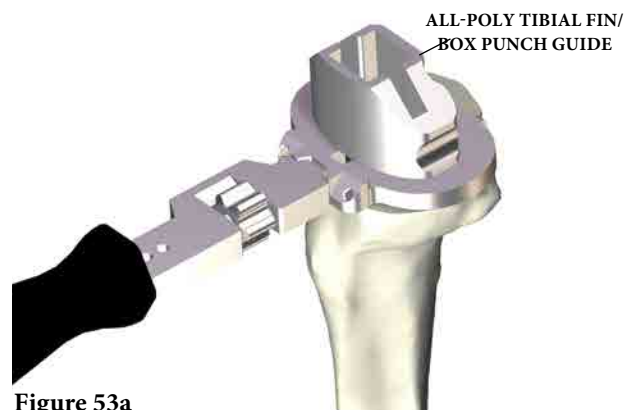

Figure 53a

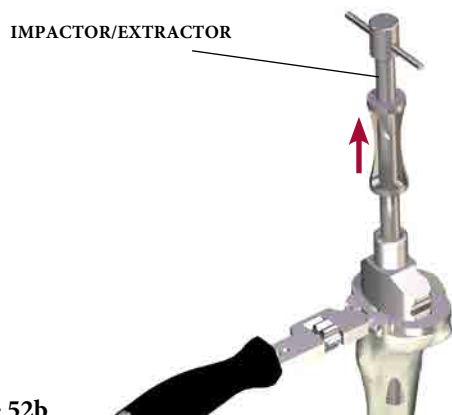

Figure 52b



Figure 53b

Care should be taken that the Tibial Template stays flush on the tibia. The **Plunger** is then inserted into the hole of the Stem Punch and impacted flush (**Figure 52a**).

This will position a bone plug at the distal tip of the Tibial Component stem, plugging the canal. Remove the plunger. The Stem Punch can be removed with the **Impactor/Extractor** (**Figure 52b**).

Initial Fin Punch

Place the rectangular **Fin/Box Punch Guide** on the Tibial Template (**Figure 53a**). Insert the initial **"Thin" Fin Punch** into the cut-out of the guide and slowly impact the punch until it is flush with the surface of the guide. During insertion, it is important to precisely control the Stem Punch, maintaining it perpendicular to the resected surface. Slowly impact the Fin Punch to allow expansion of the bone (**Figure 53b**).

Remove the Fin Punch with the Impactor/Extractor.

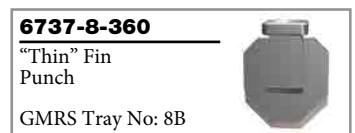
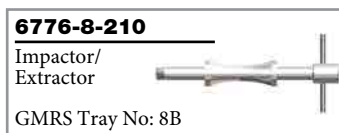



Figure 54

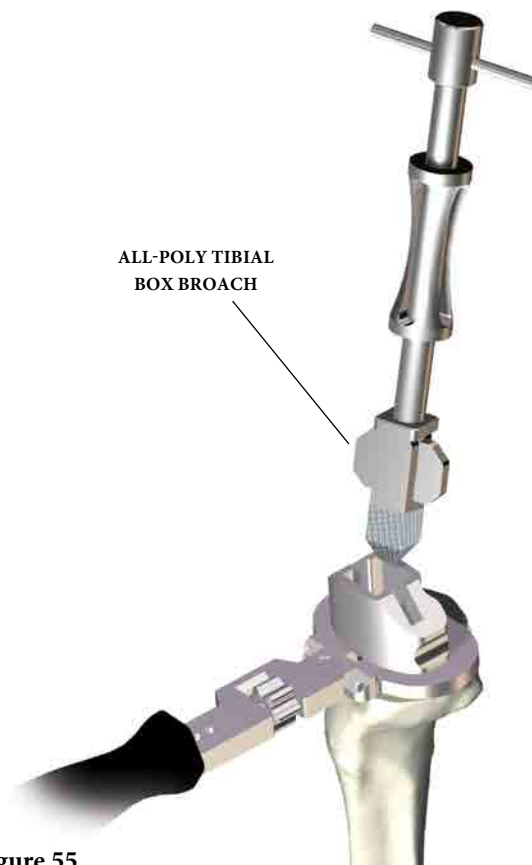

Figure 55

Initial Fin Broach

Insert the “Thick” Fin Broach (Figure 54) into the cut-out of the guide and slowly impact the broach until it is flush with the surface of the guide. During insertion, it is important to precisely control the Fin Broach, maintaining it perpendicular to the resected surface.

Remove the Fin Broach with the Impactor/Extractor.

Box Broach

Insert the Box Broach (Figure 55) into the cut-out of the guide and slowly impact the broach until it is flush with the surface of the guide. During insertion, it is important to precisely control the Box Broach, maintaining it perpendicular to the resected surface.

Remove the Box Broach with the Impactor/Extractor.

6737-8-365

“Thick” Fin Broach

GMRS Tray No: 8B



6737-8-370

Box Broach

GMRS Tray No: 8B



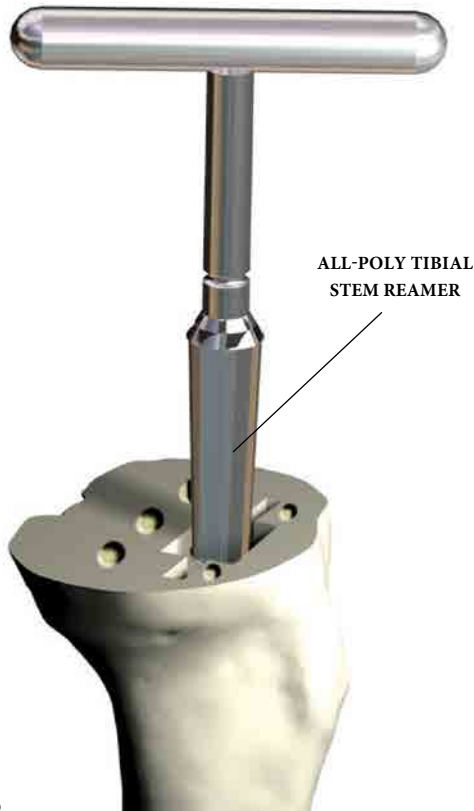

Figure 56

Final Stem Preparation

The tibial template is removed using the **Headed Nail Impactor/Extractor** and/or the Pin Puller. The **Stem Reamer (Figure 56)** is inserted into the center hole of the tibia and slowly turned in a clockwise direction and advanced into the tibia until the circumferential depth mark is flush with the cut surface of the tibia.

SURGICAL TIP: Several shallow drill holes can be made in the proximal tibia to enhance cement fixation.

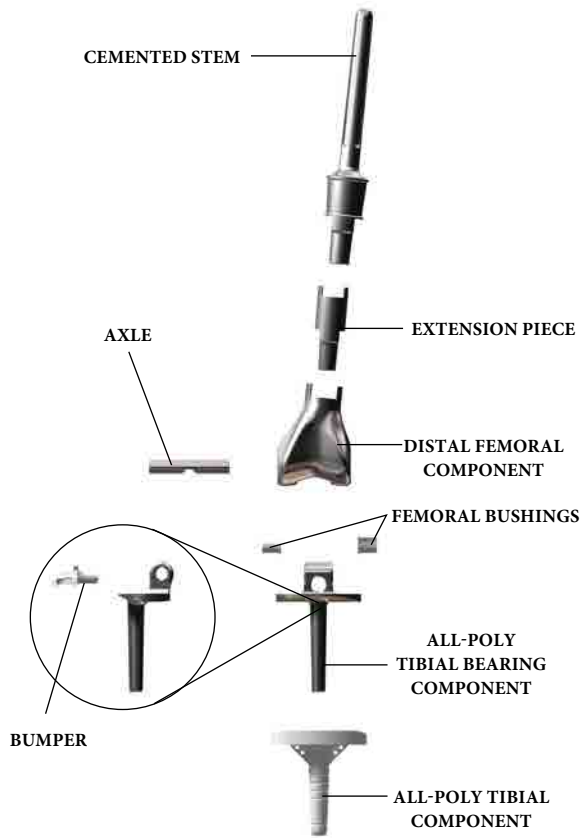

Figure 57

The Trial Assembly/Trial Reduction/Implant Assemblies (**Figure 57**) and Final Implantation follows the same steps as described on *pages 17 through 25*.

6633-7-610

Headed Nail
Impactor/Extractor
GMRS Tray
No: 8B



6737-8-375

Stem Reamer
GMRS Tray
No: 8B



APPENDIX III

Taper Disassembly

Appendix III

Taper Disassembly

Should it be necessary to disengage an assembled taper joint, a taper separator is provided. The taper separator utilizes the mechanical advantage of a wedge(s) and lever arm to overcome the locking forces of the tapers and separate the components. It is important that the separator be positioned so that the wedge(s) does not act against the anti-rotation tabs of the implants. The correct orientation is in an anterior-to-posterior direction. The implants are designed to withstand the forces generated by the separator in this direction. Placement of the separator wedges against the anti-rotation tabs may damage them, making disengagement difficult. The separator may be used via three different methods.

Method 1

The wedges are initially advanced by hand to bring them in contact with the implant at the joint to be disengaged. The wedges are advanced by turning the nut in a clockwise direction, until resistance is felt (**Figure 58a**). The wedges are then further advanced, using the wrench end of the 5-in-1 impactor provided, until the tapers disengage.

Method 2

The wedges of the separator are advanced until they are sufficiently tight against the taper junction to be separated using the wrench end of the 5-in-1 impactor. A mallet can then be used to impact the chisel component of the separator. The separator is design to allow the nut and chisel to travel a small distance when impacted to ease separation.

Method 3

The separator can be disassembled and the chisel component of the assembly can be used by itself to separate a taper junction (**Figure 58b**). The chisel is inserted anteriorly at the location to be separated and impacted with a mallet until separation is achieved.

Caution should be taken when disengaging any taper-locked joint. The high forces that hold a taper-locked joint together may result in a sudden and forceful action upon disengagement along the axis of the tapers.

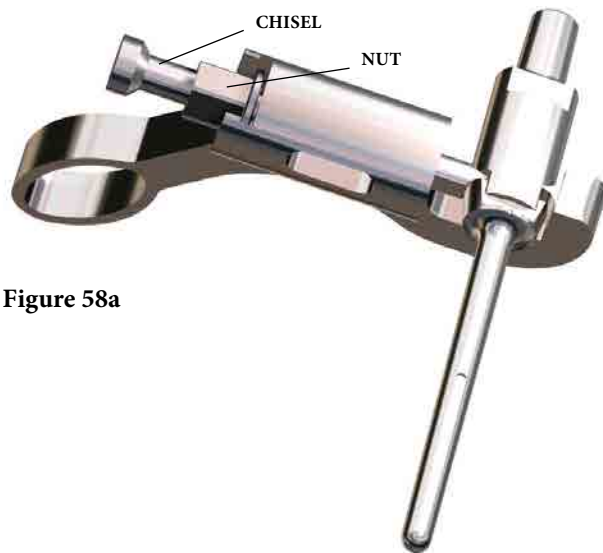

Figure 58a



Figure 58b

6496-9-054/055/056

Taper Separator



GMRS Tray 3

Distal Femur Resection Length Overview Chart

Distal Femoral Component Length	65mm
Stem Without Body	11mm
Stem With Body	40mm

Extension Piece Length	Stem Without Body	Stem With Body
None	76mm	105mm
30mm	106mm	135mm
40mm	116mm	145mm
50mm	126mm	155mm
60mm	136mm	165mm
70mm	146mm	175mm
80mm	156mm	185mm
90mm (40 + 50)	166mm	195mm
100mm	176mm	205mm
110mm (50 + 60)	186mm	215mm
120mm	196mm	225mm
130mm (50 + 80)	206mm	235mm
140mm	216mm	245mm
150mm (50 + 100)	226mm	255mm
160mm	236mm	265mm
170mm (50 + 120)	246mm	275mm
180mm	256mm	285mm
190mm (50 + 140)	266mm	295mm
200mm	276mm	305mm
210mm (50 + 160)	286mm	315mm
220mm	296mm	325mm

Implant Listing

Cat #	Description	Size
Distal Femoral Components		
6495-2-030	GMRS Distal Femur	Standard Left
6495-2-040	GMRS Distal Femur	Standard Right
6495-2-010	GMRS Distal Femur	Small Left
6495-2-020	GMRS Distal Femur	Small Right

Accessories

6481-2-120	Axle
6481-2-130	Neutral Bumper
6481-2-133	3° Bumper
6481-2-110	Bushing
6495-2-115	Small Axle
6495-2-105	Small Bushing
6481-2-140	Tibial Sleeve

Cat #	Description	Size
Extension Pieces		
6495-6-030	GMRS Extension Piece	30mm
6495-6-040	GMRS Extension Piece	40mm
6495-6-050	GMRS Extension Piece	50mm
6495-6-060	GMRS Extension Piece	60mm
6495-6-070	GMRS Extension Piece	70mm
6495-6-080	GMRS Extension Piece	80mm
6495-6-100	GMRS Extension Piece	100mm
6495-6-120	GMRS Extension Piece	120mm
6495-6-140	GMRS Extension Piece	140mm
6495-6-160	GMRS Extension Piece	160mm
6495-6-180	GMRS Extension Piece	180mm
6495-6-200	GMRS Extension Piece	200mm
6495-6-220	GMRS Extension Piece	220mm

Cat #	Description	Size
-------	-------------	------

Tibial Inserts

6481-3-210	Tibial Insert	S1/S2, 10mm
6481-3-213	Tibial Insert	S1/S2, 13mm
6481-3-216	Tibial Insert	S1/S2, 16mm
6481-3-220	Tibial Insert	S1/S2, 20mm
6481-3-224	Tibial Insert	S1/S2, 24mm
6481-3-310	Tibial Insert	M2/L2, 10mm
6481-3-313	Tibial Insert	M2/L2, 13mm
6481-3-316	Tibial Insert	M2/L2, 16mm
6481-3-320	Tibial Insert	M2/L2, 20mm
6481-3-324	Tibial Insert	M2/L2, 24mm

Tibial Baseplates

6481-3-110	MRH Tibial Baseplate	S1
6481-3-111	MRH Tibial Baseplate	S2
6481-3-112	MRH Tibial Baseplate	M2
6481-3-113	MRH Tibial Baseplate	L2

Tibial Bearing Components

6481-2-100	MRH/GMRS Tibial Bearing Component All Poly Tibial Bearing Component	All
6481-2-103	All Poly Tibial Bearing Component	All
6481-2-104	KRH/MRS Tibial Bearing Component	All
6481-2-107	Pediatric All Poly Tibial Bearing Component	All
6495-3-601	GMRS Small Proximal Tibial Bearing Component	All

Cat #	Description	Size
-------	-------------	------

All Poly Tibial Components

6485-2-008	All Poly Tibial Component	XS, 8mm
6485-2-011	All Poly Tibial Component	XS, 11mm
6485-2-016	All Poly Tibial Component	XS, 16mm
6485-2-021	All Poly Tibial Component	XS, 21mm
6485-2-108	All Poly Tibial Component	SM, 8mm
6485-2-111	All Poly Tibial Component	SM, 11mm
6485-2-116	All Poly Tibial Component	SM, 16mm
6485-2-121	All Poly Tibial Component	SM, 21mm
6485-2-208	All Poly Tibial Component	MED, 8mm
6485-2-211	All Poly Tibial Component	MED, 11mm
6485-2-216	All Poly Tibial Component	MED, 16mm
6485-2-221	All Poly Tibial Component	MED, 21mm
6485-2-308	All Poly Tibial Component	LRG, 8mm
6485-2-311	All Poly Tibial Component	LRG, 11mm
6485-2-316	All Poly Tibial Component	LRG, 16mm
6485-2-321	All Poly Tibial Component	LRG, 21mm
6485-2-408	All Poly Tibial Component	XL, 8mm
6485-2-411	All Poly Tibial Component	XL, 11mm
6485-2-416	All Poly Tibial Component	XL, 16mm
6485-2-421	All Poly Tibial Component	XL, 21mm

Cat #	Description	Size
GMRS Straight Stems with Porous Coated Body Section		
6485-3-008	GMRS Straight Stem with Porous Coated Body Section	8mm
6485-3-009	GMRS Straight Stem with Porous Coated Body Section	9mm
6485-3-000	GMRS Straight Stem with Porous Coated Body Section	10mm
6485-3-011	GMRS Straight Stem with Porous Coated Body Section	11mm
6485-3-013	GMRS Straight Stem with Porous Coated Body Section	13mm
6485-3-015	GMRS Straight Stem with Porous Coated Body Section	15mm
6485-3-017	GMRS Straight Stem with Porous Coated Body Section	17mm

GMRS Straight Stems without Porous Coated Body Section

6485-3-018	GMRS Straight Stem without Porous Coated Body Section	8mm
6485-3-019	GMRS Straight Stem without Porous Coated Body Section	9mm
6485-3-010	GMRS Straight Stem without Porous Coated Body Section	10mm
6485-3-111	GMRS Straight Stem without Porous Coated Body Section	11mm
6485-3-113	GMRS Straight Stem without Porous Coated Body Section	13mm
6485-3-115	GMRS Straight Stem without Porous Coated Body Section	15mm
6485-3-117	GMRS Straight Stem without Porous Coated Body Section	17mm

GMRS Curved Stems with Porous Coated Body Section

6485-3-308	GMRS Curved Stem with Porous Coated Body Section	8mm
6485-3-309	GMRS Curved Stem with Porous Coated Body Section	9mm
6485-3-300	GMRS Curved Stem with Porous Coated Body Section	10mm
6485-3-711	GMRS Curved Stem with Porous Coated Body Section	11mm
6485-3-713	GMRS Curved Stem with Porous Coated Body Section	13mm
6485-3-715	GMRS Curved Stem with Porous Coated Body Section	15mm
6485-3-717	GMRS Curved Stem with Porous Coated Body Section	17mm

Cat #	Description	Size
GMRS Curved Stems without Porous Coated Body Section		
6485-3-318	GMRS Curved Stem without Porous Coated Body Section	8mm
6485-3-319	GMRS Curved Stem without Porous Coated Body Section	9mm
6485-3-310	GMRS Curved Stem without Porous Coated Body Section	10mm
6485-3-811	GMRS Curved Stem without Porous Coated Body Section	11mm
6485-3-813	GMRS Curved Stem without Porous Coated Body Section	13mm
6485-3-815	GMRS Curved Stem without Porous Coated Body Section	15mm
6485-3-817	GMRS Curved Stem without Porous Coated Body Section	17mm

GMRS Long Stems with Porous Coated Body Section

6485-3-311	GMRS Long Stem with Porous Coated Body Section	11mm
6485-3-313	GMRS Long Stem with Porous Coated Body Section	13mm
6485-3-315	GMRS Long Stem with Porous Coated Body Section	15mm
6485-3-317	GMRS Long Stem with Porous Coated Body Section	17mm

GMRS Long Stems without Porous Coated Body Section

6485-3-611	GMRS Long Stem without Porous Coated Body Section	11mm
6485-3-613	GMRS Long Stem without Porous Coated Body Section	13mm
6485-3-615	GMRS Long Stem without Porous Coated Body Section	15mm
6485-3-617	GMRS Long Stem without Porous Coated Body Section	17mm

Cat #	Description	Size
Cobalt Chrome Stems (For MRH Baseplate)		
6478-6-395	CoCr Stem	10 x 80mm
6478-6-396	CoCr Stem	11 x 80mm
6478-6-397	CoCr Stem	12 x 80mm
6478-6-398	CoCr Stem	13 x 80mm
6478-6-399	CoCr Stem	14 x 80mm
6478-6-400	CoCr Stem	15 x 80mm
6478-6-405	CoCr Stem	16 x 80mm
6478-6-410	CoCr Stem	17 x 80mm
6478-6-415	CoCr Stem	18 x 80mm
6478-6-420	CoCr Stem	19 x 80mm
6478-6-425	CoCr Stem	21 x 80mm
6478-6-430	CoCr Stem	23 x 80mm
6478-6-435	CoCr Stem	10 x 155mm
6478-6-436	CoCr Stem	11 x 155mm
6478-6-437	CoCr Stem	12 x 155mm
6478-6-438	CoCr Stem	13 x 155mm
6478-6-439	CoCr Stem	14 x 155mm
6478-6-440	CoCr Stem	15 x 155mm
6478-6-445	CoCr Stem	16 x 155mm
6478-6-450	CoCr Stem	17 x 155mm
6478-6-455	CoCr Stem	18 x 155mm
6478-6-460	CoCr Stem	19 x 155mm
6478-6-465	CoCr Stem	21 x 155mm
6478-6-470	CoCr Stem	23 x 155mm

Cat #	Description	Size
Titanium Fluted Stems (For MRH Baseplate)		
6478-6-600	Ti Fluted Stem	10 x 80mm
6478-6-605	Ti Fluted Stem	11 x 80mm
6478-6-610	Ti Fluted Stem	12 x 80mm
6478-6-615	Ti Fluted Stem	13 x 80mm
6478-6-620	Ti Fluted Stem	14 x 80mm
6478-6-625	Ti Fluted Stem	15 x 80mm
6478-6-630	Ti Fluted Stem	16 x 80mm
6478-6-635	Ti Fluted Stem	17 x 80mm
6478-6-640	Ti Fluted Stem	18 x 80mm
6478-6-645	Ti Fluted Stem	19 x 80mm
6478-6-655	Ti Fluted Stem	21 x 80mm
6478-6-665	Ti Fluted Stem	23 x 80mm
6478-6-680	Ti Fluted Stem	10 x 155mm
6478-6-685	Ti Fluted Stem	11 x 155mm
6478-6-690	Ti Fluted Stem	12 x 155mm
6478-6-695	Ti Fluted Stem	13 x 155mm
6478-6-705	Ti Fluted Stem	14 x 155mm
6478-6-710	Ti Fluted Stem	15 x 155mm
6478-6-715	Ti Fluted Stem	16 x 155mm
6478-6-720	Ti Fluted Stem	17 x 155mm
6478-6-725	Ti Fluted Stem	18 x 155mm
6478-6-730	Ti Fluted Stem	19 x 155mm
6478-6-740	Ti Fluted Stem	21 x 155mm
6478-6-750	Ti Fluted Stem	23 x 155mm

Reconstructive

Hips

Knees

Trauma & Extremities

Foot & Ankle

Joint Preservation

Orthobiologics & Biosurgery

MedSurg

Power Tools & Surgical Accessories

Computer Assisted Surgery

Endoscopic Surgical Solutions

Integrated Communications

Beds, Stretchers & EMS

Reprocessing & Remanufacturing

Neurotechnology & Spine

Craniomaxillofacial

Interventional Spine

Neurosurgical, Spine & ENT

Neurovascular

Spinal Implants

325 Corporate Drive
Mahwah, NJ 07430
t: 201 831 5000

www.stryker.com

A surgeon must always rely on his or her own professional clinical judgment when deciding whether to use a particular product when treating a particular patient. Stryker does not dispense medical advice and recommends that surgeons be trained in the use of any particular product before using it in surgery.

The information presented is intended to demonstrate the breadth of Stryker product offerings. A surgeon must always refer to the package insert, product label and/or instructions for use before using any Stryker product. The products depicted are CE marked according to the Medical Device Directive 93/42/EEC. Products may not be available in all markets because product availability is subject to the regulatory and/or medical practices in individual markets. Please contact your Stryker representative if you have questions about the availability of Stryker products in your area.

Stryker Corporation or its divisions or other corporate affiliated entities own, use or have applied for the following trademarks or service marks: GMRS, Kinematic, Stryker, Stryker Orthopaedics. All other trademarks are trademarks of their respective owners or holders.